

**Table of Contents**

Table of Contents ..... 1

Pipe Bending ..... 6

    Hydraulic Pipe Bending Machines ..... 6

    Proline 04-20 HD Bending Machine..... 6

    Proline 16-30 Bending Machine..... 6

    Proline 30-42 Bending Machine..... 6

    Proline 36-48 Bending Machine..... 6

    Hydraulic Pipe Bending Machine Spec's ..... 7

    Pipe Bending Die Sets..... 7

Proline Multi-Strap Tractor Bending Shoe ..... 8

Pipe Bending Mandrels..... 9

    Proline Internal Pneumatic Wedge Type Mandrels ..... 9

    Proline Internal Hydraulic Wedge Mandrels..... 10

    Proline Internal Hydraulic Wedge Mandrels "Self Contained" ..... 10

Pipe Bend Measurement Tools..... 11

    Abney Eye Level..... 11

    Bending Protractor ..... 11

    AccuBend Electronic Bend Indicator..... 12

Internal Line Up Clamps ..... 13

    Proline Pneumatic Internal Lineup Clamp (Pull-Type)..... 13

    Proline Pneumatic Internal Lineup Clamp (Self-Propelled) ..... 13

Portable Wash Pads ..... 14

    Enviro Pads™ Portable Wash Pads ..... 14

Pumps..... 15

    Jerry Can Test Pump ..... 15

    High Pressure Jerry Can Test Pump ..... 15

Air Compressors ..... 16

Pipe Cradles ..... 17

    Pneumatic Tired Cradle..... 17

    Rolli Cradle ..... 17

Horizontal Pipe Rollers ..... 18

    2"- 24" Horizontal Pipe Roller ..... 18

    2"- 48" Horizontal Pipe Roller..... 18

    Heavy Duty "HD" Horizontal Pipe Rollers..... 19

    Proline 2"-24" HD Horizontal Pipe Roller ..... 19

    Proline 2"-30" HD Horizontal Pipe Roller ..... 19

    Proline 2"-48" HD Horizontal PipeRoller..... 20

    Proline Adjustable 16"-48" HD Horizontal Pipe Roller ..... 20

Outlaw Padding Bucket..... 21

Lowering In Belts ..... 22

    Nylon Lifting Belt ..... 22

    Nylon Lifting Belt Head Iron..... 22

    Round Endless & Web Slings..... 22

    Round Sling Load Ratings..... 23

Pipe Handling Supplies..... 24

    Pipe Hooks ..... 24

Plastic Pipestands .....	24
Hi Temp Plastic Pipestands.....	25
Plastic Cable Stands .....	26
30"-48" Plastic Pipe Trench Support .....	27
Pipe Stringing Chute .....	27
Solid Tripod Stands.....	28
Collapsible Tripod Stands.....	29
Javelin Collapsible Tripod Stands.....	30
Javelin Rollerheads.....	32
Sawhorse Stands .....	33
Adjustable Heavy Duty Pipe Rollers .....	33
Pipe Dollies .....	34
Deckhand LaValley Excavator Attachments .....	35
Vacuworx Vacuum Lifting System .....	35
Vacuworx Spec's.....	37
MatJack Air Lifting Bags .....	38
MatJack Accessories.....	38
MatJack Air Lifting Bag Specs .....	39
Pipe Puller .....	40
Induction Heating Equipment .....	41
Gen Set and Induction Heating Coils .....	41
Tape and Primer.....	42
Renwrap®.....	42
Royston Mastics® .....	42
Polyguard.....	43
Tapecoat® Protective Coatings .....	43
Denso® Tapes and Primers .....	44
Rock Shield .....	45
Tuff-N-Nuff Rockshield .....	45
Coating Products .....	46
3M™ Scotchkote™ Fusion-Bonded Epoxy Coating 134.....	46
3M™ Scotchkote™ Liquid Epoxy Coating 323, Brush Grade .....	46
3M™ Scotchkote™ Patch Stick 226P, Green, 5 lb.....	46
Canusa K-60 Shrink Sleeves.....	47
Canusa Wrapid Tape™ .....	47
TBK (Thrust Bore Kits) .....	47
HBE-95 .....	47
E-Primer.....	48
GTS-PE .....	48
INR-110.....	49
Coating Repair Products .....	49
Paint / Chip Brushes and Cage Rollers.....	50
Sleeve Application .....	51
J-Rollers.....	51
Vapor Propane Torches .....	51
Sievert HK 1-30 Hot-Air Detail .....	51
Propane Accessories .....	52
Vapor Propane Hoses, Regulators, and Tanks.....	52
Liquid Propane Hoses, Regulators, and Tanks.....	52

Holiday Detection.....	54
Spy® Holiday Detectors .....	54
Spy® Model 790.....	54
Spy® Model 785.....	54
Spy® Model 780.....	54
Spy® Model 670 Wet Sponge Detector .....	54
SPY® Jeepmeter .....	55
SPY® Model JM.....	55
SPY® Model PJM .....	55
SPY® Model DCPJM .....	55
SPY® Pig Tracker and Sensor .....	56
Beveling Equipment.....	57
H&M Saddle Type Beveler .....	57
Compact Bevelers .....	57
Quick Set Bevelers.....	57
Sawyer Beveling Bands .....	58
Manual Crawlers .....	58
Motorized Crawlers.....	58
Proline Crawler Motorization Kit.....	59
Sawyer Cordless Motorized Crawler .....	60
Radiograph Cutters .....	61
Victor® Machine Cutting Torches & Tips .....	61
Victor® Regulators .....	61
Cutting Tips.....	61
Cold Cutters.....	62
Reed Cold Pipe Cutters.....	62
Tents .....	63
Welding Supplies.....	65
Welding Blankets .....	65
Welding Umbrellas .....	65
Cat Tarp.....	65
Spacing Tools & Wedges .....	65
Wedges.....	66
Show Dawgs .....	67
Welding Tools.....	67
Magnetic Ground Clamp.....	67
Magnetic Grinder Holder .....	67
External Lineup Clamps.....	68
Chain Clamps.....	68
Ratchet Clamps .....	70
Lever Clamps .....	70
Fast Fitting Clamps .....	71
Misc. Supplies .....	72
Instruments and Gauges.....	73
ATKINS 35100-K Thermocouple.....	73
Positector Wall Thickness Gauge.....	74
Positest FM Thickness Gauge.....	75
Testex Spring Micrometer.....	75
Testex Tape .....	76

Wet Film Thickness Gauge .....	76
Firm Joint Calipers .....	77
G.A.L. Pit Gauge .....	78
Tri Gauge .....	78
Hi-Lo Gauge .....	78
Gauss Meters .....	79
Pipe Wrap .....	79
Pipeline Pigs .....	80
Foam Pigs .....	80
Urethane Pigs .....	82
Construction Pigs .....	83
Plugs and Gas Bags .....	84
Logiball® Securimax Multisize Plugs .....	84
Wing Nut Test Plug .....	85
Cherne® Test Plugs .....	85
Gas Bags .....	86
Inflatable Multi-Sized Purge Bladders .....	86
Mud Plug Kits .....	87
Pipe Seals & Spacers .....	88
Link Seals .....	88
End Seals .....	89
Casing Spacers (Non Metallic) .....	90
Casing Spacers (Metalic) .....	90
Century Sleeves .....	91
Flange Tools .....	92
Titan® Flange Spreader .....	92
Pop-It® Tool Flange Spreader .....	92
Heavy Duty Pop-It® Flange Spreader .....	92
Flange Alignment Tool .....	93
Flange Line Up Pins .....	94
Broadhead Bull Pins .....	95
Standard Bull Pins .....	95
Drift Pins .....	95
Flange and Pipe Rotator .....	95
Flange Lifting Tool .....	96
L1020 & FL2448 Horizontal Flange Lifters .....	97
Flange Protection .....	97
Disc Style Flange Protection .....	97
LDPE Stud Hole Flange Protection .....	97
Flange Armour - Flange Protection .....	98
Pipe Protection .....	99
Pipe Armour .....	99
Plastic End Caps .....	100
Cathodic Protection .....	101
Cathodic Test Post Station .....	101
Cadweld Connection Kit .....	101
Royston Handy Caps .....	101
Trencher and Auger Parts .....	102
Trencher Parts, Teeth and Pockets .....	102

Auger Teeth and Bits.....	102
Locators.....	103
VM-810 / VM-850 .....	103
VLoc3-9800.....	103
VLoc3-5000.....	104
VLoc3 RTK-Pro .....	104
Vivax vLoc 3 Pro .....	105
VM-880 Ferrous Metal Detector .....	106
VM-560 .....	106
Service & Repairs .....	107

**Proline Pipe Equipment Inc.**

**Hydraulic Pipe Bending Machines**



**Check out the PROLINE Advantage:**

- For pipe sizes from 04" (114.3 mm) up to 48"(1219.2mm)
- Oversized hydraulic tanks with internal cooling baffles prevent overheating of the hydraulic fluid, no matter how extreme the jobsite conditions
- Safety shutdown instruments immediately shut off the engine in case of low oil pressure or high temperature, to prevent engine damage
- Emergency shutoff on the engine air intake allows bending machine operator to instantly stop the engine in case flammable or explosive gases are present in the air
- Safety steel plate in front of the operator platform protects the operator from the danger of hydraulic leaks or burst hydraulic hoses
- Powered by a CAT turbo diesel or Deutz air-cooled diesel engine with electric start and emergency shutdown
- Instruments, gauges and controls are located directly in front of the operator for easy use
- Hydraulic drive pipe movement winch
- Fully mobile with rubber tires or steel tracks with a hydraulic towing tongue
- Polyurethane lined bending die sets provide smooth, non-scarring surfaces for bending bare or pre-coated pipe. Replacement polyurethane shells are available at reasonable cost

- 1) Each pipe size within a machine's range requires a different bending set.
- 2) Specially-lined bending die sets, to prevent damage when bending pre-coated pipe, are available.



**Proline 04-20 HD Bending Machine**

- Bends pipe Range 4" up to 20"
- HD model includes air compressor to run mandrel



**Proline 16-30 Bending Machine**

- Bends pipe Range 16" up to 30"
- Air compressor to run mandrel is standard



**Proline 30-42 Bending Machine**

- Bends pipe Range 30" up to 42"
- Air compressor to run mandrel is standard



**Proline 36-48 Bending Machine**

- Bends pipe Range 36" up to 48"
- Air compressor to run mandrel is standard

**Hydraulic Pipe Bending Machine Spec's**



MODEL NO.	BM04-20	BM04-20HD	BM 16-30	BM20-36	BM30-42	BM36-48
PIPE SIZE	4"-20"	4"-20"	16"-30"	20"-36"	30"-42"	36"-48"
HEIGHT	8'-6" / 2.59 m	8'-6" / 2.59 m	8' - 0" / 2.44 m	10'-0" / 3.05 m	11'-6" / 3.51 m	11'-6" / 3.51 m
LENGTH	15'-5" / 4.70 m	24' / 7.32 m	22'-9" / 6.93 m	26'-3" / 8.0 m	30'-6" / 9.30 m	30'-6"/9.30 m
WIDTH	6'-1"	6'-1"	8' - 0" / 2.44 m	8'-6"	10'-0"	11'-0"
WEIGHT	10,000 lbs 4540 kg.	12,000 lbs 5450 kg.	31,000 lbs 14,074 kg	41,000 lbs 18,614 kg.	86,000 lbs 39,044 kg.	140,500 lbs 63,787 kg.
CUBES	689 cu. ft. 19.5 m <sup>3</sup>	797 cu. ft. 22.6 m <sup>3</sup>	1456 cu. ft. 41.2 m <sup>3</sup>	1887 cu. ft. 53.4 m <sup>3</sup>	2625 cu. ft. 74.29 m <sup>3</sup>	3858 cu. ft. 109.19 m <sup>3</sup>
ENGINE	DIESEL 40 hp @ 2200 rpm	DIESEL 45 hp @ 2200 rpm	DIESEL 84 hp @ 2200 rpm	DIESEL 84 hp @ 2200 rpm	DIESEL 84 hp @ 2200 rpm	DIESEL 180 hp @ 2200 rpm
COMPRESSOR	N/A	HYD. Driven	HYD. Driven	HYD. Driven	Gas Engine Driven	Gas Engine Driven
WINCH	HYD.	HYD.	HYD.	HYD.	HYD.	HYD.

**Pipe Bending Die Sets**



Urethane-lined for use with Bending Machines for pipe diameters 4"-20" (114.3 mm – 508 mm) and 16" – 48" (406.4 mm – 1219.2 mm)

**Standard package**

Bending Die, Stiffback Liner and Pinup Liner (additional Stiffback Liner and Two Cynch Liners for larger bending machines)

**Heavy-Duty package (Model BM04-20)**

Bending Die, Stiffback Liner, Stiffback Extension and Pinup Liner



**Proline Multi-Strap Tractor Bending Shoe**



- Bends pipe easily and economically
- Easily mounted on side boom equipped tractors
- Bends pipe from 2" TO 8" (50mm – 203.2mm)
- Rugged - Built for the toughest conditions
- Bending straps are easily replaced (No need to replace entire belt if damaged)

**Installation Details**

- Mounting plate A is welded to boom B.
- Dead eyes C and D are welded to top of boom B.
- Mounting bracket G is bolted to adapter plate A.
- Bending shoe E and adapter assembly F is pinned to mounting bracket G, using pin H.
- Static line I is attached to top of boom at C.



**Operating Instructions**

- Static line I is attached to one end of pipe about 10 feet from bending shoe.
- Sideboom load line J is attached to other end of pipe (for maximum bending force, load line should be attached about 10 feet from bending shoe).
- Pulling on load line draws pipe into bending shoe E.
- Continued pull on load line bends pipe in shoe.

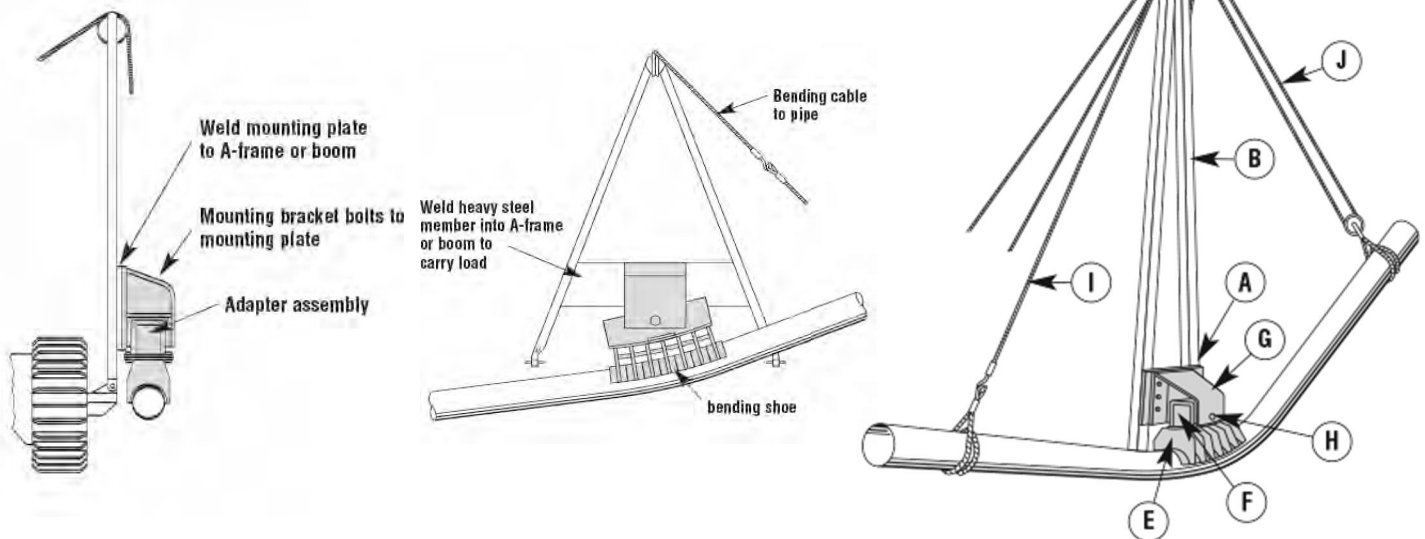

PROLINE Pipe Bending Mandrels are a vital piece of equipment for any pipe bending operation. Using the latest technologies and materials, PROLINE mandrels are guaranteed to withstand the extreme forces of bending. Our unique wedge design allows smooth bends to be made while preventing pipe buckling and shape distortion of higher grades of pipe.

PROLINE's self-centering / no-roll technology insures that the mandrel will always stay centered in the pipe. Designed and engineered for a one-man operation, PROLINE mandrels come in hydraulic or pneumatic wedge styles. Comes in a variety of sizes for different pipe diameters.

### Features:

- Extremely powerful large diameter cylinders
- Polyurethane-coated backing bars, pads and wheels for the protection of internal coated pipes
- Can be used with X65 to X80+ grade pipe
- Conversion kits available to adjust for different pipe size in range
- Self propelled air motor (some hydraulic motor driven) - 20" and larger
- Fast Action – retracts, expands and travels quickly
- Rugged and built for long life
- Very low maintenance



## Proline Internal Pneumatic Wedge Type Mandrels



Proline  
Mfg.

The PROLINE Pneumatic Pipe Bending Mandrel is a wedge style bending mandrel for the internal support of 8" to 60" (219-1524 mm) diameter steel pipe of any grade and wall thickness. The user-friendly design does not require side roll adjustment. The larger mandrels offer a very strong actuation system using two large pneumatic cylinders pushing and pulling the wedge system into position. Equipped with 40 feet (12.19 M) of reach rod, control ends and owner's manual



## Proline Internal Hydraulic Wedge Mandrels

The PROLINE Internal Hydraulic Wedge Pipe Bending Mandrel is available in two models for pipe sizes 20" to 60" (508-1524 mm).

Features:

- Self-propelled by powerful hydraulic motors
- Mandrels of 20" to 32" (508-812.8 mm) feature a direct chain drive from the hydraulic motor to the travel wheels
- Mandrels of 34" to 60" (863.6-1524 mm) feature two hydraulic, direct input motors mounted directly on the two front travel wheels (eliminates the need for chains or gears)

Optional:

- Hydraulic conversion kit for bending machines to operate mandrels
- Portable hydraulic power unit to operate mandrels



## Proline Internal Hydraulic Wedge Mandrels "Self-Contained"

The PROLINE Internal Hydraulic Wedge Pipe Bending Mandrel is available for pipe sizes 34" to 60" (863.6-1524 mm) and is engineered to meet the bending specifications of high-grade pipe used on natural gas pipeline projects. Like all PROLINE mandrels the hydraulic self-contained wedge mandrel has the no roll self-leveling technology incorporated into the design. Combined with the self-contained diesel power source, this mandrel helps speed up the bending process dramatically.

Features:

- Self-propelled by two powerful hydraulic motors mounted directly on the two front travel wheels eliminating the need for chains and gears
- Air cooled diesel engine and hydraulic system integrated into the mandrel
- No external hydraulic system
- No need for hose filled reach rod
- All models come with light weight electric wire filled reach rod, compact pneumatic tire control buggy and control juncture box

Optional:

- Remote control operation – eliminates the need for electric wire filled reach rod



### Abney Eye Level

Proline offers two sizes of quality-made eye levels which are affordable, accurate and easy to use.

The Abney Eye Level consists of a fixed sight tube with a movable bubble that's connected to a pointing arm and protractor scale.

This surveyor's instrument is used to measure degrees when bending pipe.

Other uses include measuring percent of grade, topographic elevation and chain correction.

- Arc graduated in degrees 0-60°
- Percent scale 0-100%
- Complete with scale, clamp lock and leather case
- Telescope measures 16cm long



### Bending Protractor

- Measures angles quickly and accurately
- Radius arc is equally divided to single degrees (60° - 0° -60°)
- Vernier arm reads angle to 15 minutes of a degree
- Level vial is easily adjusted to reference base
- Detachable base magnets with magnetic keepers
- Small & Lightweight, made of corrosion resistant metal

Use the bending machine to hold the pipe snug, take the protractor and set it to zero at point **A** while making sure the "bubble" on the protractor is centered between the lines in the



glass level. Make a small bend. Relax the machine so the pipe lies free in the bed of the bending machine. Place the protractor on the end of the pipe **B** where it was bent and mark the spot. Turn the knob to make sure the "bubble" is entered between the lines on the glass level. The number indicated on the scale will be the angle at which the pipe was bent.



## AccuBend Electronic Bend Indicator



The AccuBend electronic bend indicator is one of the most advanced bend measurement systems on the market today.

### Advantages:

#### For Safety:

Virtually eliminates climbing on the pipe.

#### For Accuracy:

Continuous readout of the bend to 1/10 degree.

#### For Efficiency:

Keeps the work moving - no need to stop to measure bends.



### How it works:

AccuBend measurement system consists of two transmitters and one receiver. The receiver is mounted at the operator's stand. Once the transmitters are set on the pipe, the angle of the bend is continuously displayed. In the normal operating mode, the receiver computes the net bend in the pipe, regardless of any bending machine incline.

### Standard Features:

- Fits any size pipe
- Accuracy to 1/10 degree
- Constant digital readout
- Saves time and increases production
- Automatic shutoff feature to preserve battery life
- Relative angle may be set by the flip of a switch on the receiver
- Serialized radio frequencies allow more than one set to work in the same area without interfering with each other.
- Transmitters have a magnetic base for secure placement on the pipe
- Easy to operate and maintain

PROLINE manufactures and supplies a variety of Line Up Clamps. Our clamps ensure accurate alignment of two joints of pipe and are quick and easy to adjust for different pipe wall thickness. *All PROLINE clamps have proven themselves in thousands of miles of pipeline construction even under the most extreme field conditions.*



PROLINE Pneumatic Internal Line Up Clamps assure a rapid, accurate alignment of two joints of pipe during the welding operation. Front and rear heads operate independently to lock the clamp into position. Specially designed shoes on each head exert pressure uniformly around the inside circumference of the pipe to maintain necessary alignment. Each Lineup Clamp is quickly and easily adjusted for different pipe wall thickness. Clamps 16" (406.4 mm) or larger are self-propelled with powerful air motors that drive the clamp forward through the pipe to the next joint.



## Proline Pneumatic Internal Lineup Clamp (Pull-Type)



The PROLINE non-powered Pneumatic Internal Line Up Clamp is a pull type suitable for use in welding small diameter steel pipe from 8" – 14" (203.2 mm – 355.6 mm).

Features:

- Air reservoir tank
- Two double acting cylinders
- Independent front and rear line up heads
- 100 feet of reach rod and control ends
- Operation and maintenance manuals



## Proline Pneumatic Internal Lineup Clamp (Self-Propelled)



The PROLINE Pneumatic Internal Line Up Clamp is suitable for use in welding a wide range of pipe diameters from 16" - 60" (406.4 mm – 1524 mm) steel pipe and feature a powered forward and reverse.

Features:

- Forward / reverse travel motor
- Air reservoir tank
- Two double acting air cylinders to propel clamp a double joint distance
- Independent front and rear line up heads
- 100 feet of reach rod and control ends
- Operation and maintenance manuals



PROLINE Conversion kit available to quickly adjust clamp for different size pipe.  
***Kick-off field training service available for all size internal clamps.***

**Enviro Pads™ Portable Wash Pads**



Portable Wash Pad's are a proactive alternative for steam cleaning, pressure washing and servicing of equipment. Enviro-Pads - Wash Pad provides containment of used wash water and contaminated waste allowing for disposal in an environmentally approved manner. Wash Pads are portable and reusable eliminating ground and surface water contamination.

**Standard Features**

- Steel construction
- Engineered certified
- Pads interlock - for custom sizing
- Connection hoses - maximum fluid volume storage
- Forklift tubes and lifting eyes for installation and removal
- Non slip working surface
- Surface load rating up to 30 & 50 ton per pad

**Options**

- Enviro-Mats - when using track equipment
- Enviro-Walls - prevent over spray
- Ramps - Drive on/off
- Truck undercarriage wash ramps
- Portable pressure washer units
- Heat coils for winter work



Enviro-Pads Containment Systems: Constructed out of high-grade steel. Manufactured in widths of 16' and 20', with a standard length of 8', and heights of 7" or 12".

Typical pipeline equipment wash station: 20'x32'x12" height with 4 ramps and walls down both sides...

- Total surface rating: 200,000 lbs
- Transport weight: 36,000 lbs (truck or trailer deck space required 21')
- Fluid volume capacity: 3840 Gallons
- Safe and easy to clean out with removable grating
- Non-Slip work surface
- Setup time: 30 Minutes



Standard Specifications		
8'x20'x12" height	8'x16'x7" height	8'x16'x12" height
<ul style="list-style-type: none"> <li>• 30 &amp; 50 Ton: weights: 7,500 lbs/pad</li> <li>• 30 &amp; 50 Ton: volume 960 imp gal/pad</li> </ul>	<ul style="list-style-type: none"> <li>• 30 Ton: weights 3,700 lbs/pad</li> <li>• 30 Ton: volume 480 imp gal/pad</li> </ul>	<ul style="list-style-type: none"> <li>• 30 Ton: weights 5,500 lbs/pad</li> <li>• 30 Ton: volume 768 imp gal/pad</li> </ul>

*Enviro-Pads Containment Systems Inc. meet the stringent guidelines set out by the Energy Resources Conservation Board (ERCB), Alberta Environment (AENV), and the Fire Code of Alberta*

## Jerry Can Test Pump

### CVS Portable Injection Hand Pump

This portable hand pump of rugged design is available in both high-pressure and low-pressure models. This Injection Hand Pump will quickly and effectively de-ice valves and lines with a few strokes.

The hand pump is mounted on a 20-litre (5 gallon) metal container. Other features include adjustable pressure settings (1000, 2000 and 3000 psi), rubber core steel braided discharge hose for easy connections, convenient pressure relief valve and a discharge stroke volume of .730 cu. in or 11.96 ml.



## High Pressure Jerry Can Test Pump

### XHP 10000 High Pressure Portable Chemical Injection Hand Pump

The XHP 10000, is a portable chemical injection hand pump capable of injection pressure to a maximum of 10000 psi. The portable injection hand pump is used to introduce methanol to effectively thaw frozen lines. Other applications may include hydro testing. The XHP 10000 utilizes a 10000 psi line check to maintain the pump pressure in the process installation. A supplied needle valve is incorporated to relieve the line pressure in the hose. The hand pump is mounted on a durable 5 gallon (20 L) tank. The 7 foot long injection hose utilizes a swivel fitting to easily install to most applications. The XHP 10000 is field serviceable, and **additional support and repair kits are** readily available.



**Air Compressors**



PROLINE's Air Compressor Skid Units are designed for use with PROLINE's pneumatic equipment. Our air compressors come complete with self-contained skids and rollover cages. Three models are available:

**Model 325:**

- For use with pull style clamps and mandrels up to 12"
- Gasoline engine with electric start (electric motor driven optional)
- Operating pressure: 175–190 PSI

**Model 350:**

- For use with pull style clamps and mandrels up to 18"
- Diesel engine with electric start (electric motor driven optional)
- Operating pressure: 175–220 PSI

**Model 370:**

- For use with all self-propelled clamps and mandrels up to 30"
- Diesel engine with electric start (gasoline engine or electric motor driven optional)
- Operating pressure: 190–220 PSI

**Model 390:**

- For use with all self-propelled clamps and mandrels over 32"
- Diesel engine with electric start (gasoline engine or electric motor drive optional)
- Operating pressure: 190–220 PSI

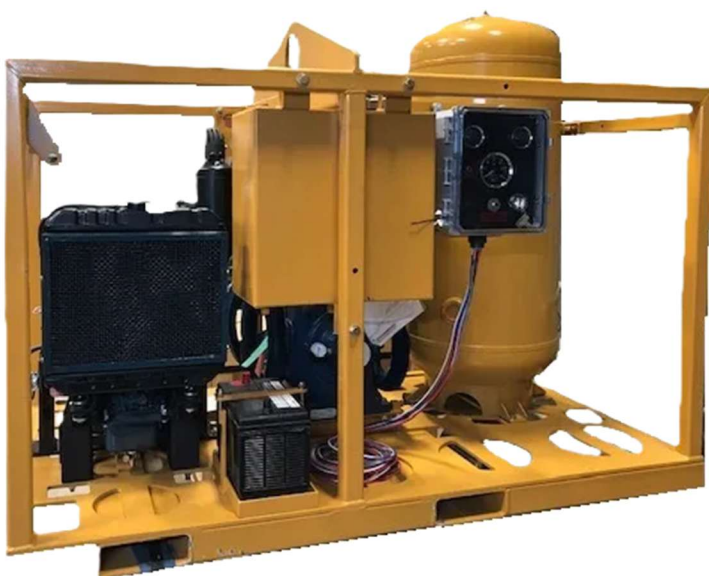

## Pneumatic Tired Cradle

- Supports and safely guides the pipe during the lowering-in operation
- Available models to accommodate pipe sizes from 2" to 48" (60.3 mm – 1219.2mm)
- Large pneumatic tires are mounted on a strong frame with pipe guide rollers, cables and head iron
- Insulated, coated and wrapped pipe can be handled without damage



## Rolli Cradle

- Wraps around the pipe and forms a continuous roller surrounding the pipe's lower half
- For pipe from 2" to 60" (60.3 mm – 1524 mm) in diameter
- Pipe can be kept close to the ground allowing operators more control and mobility
- Polyurethane rollers make it ride easily over weld seams and eliminates pipe coating damage



Spreader bar available for supporting multiple cradles with single lifting device. Ideal for situations where pipeline weight is concentrated as when pulling bores or crossings



Lightweight and easy to handle Rolli Slings are available for pipe sizes 2" - 6"

## Horizontal Pipe Rollers



Application: Tapered Urethane Roller to help protect coatings during river/road crossing installations.

## 2"- 24" Horizontal Pipe Roller



- 2" – 24" Pipe Roller
- Load Capacity: 2000 lbs
- Pipe Diameter Range: 2" – 24"
- Weight: 75 lbs
- Dimensions: 24" Length, 16" Width, 8" Height

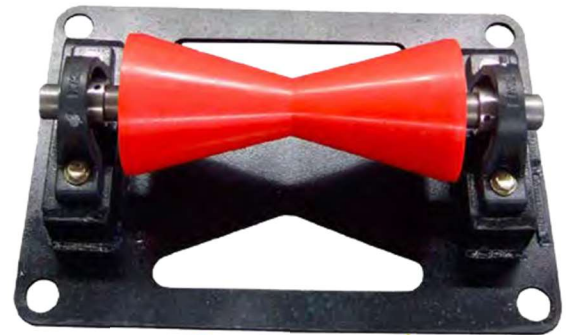

## 2"- 48" Horizontal Pipe Roller



- 2" – 48" Pipe Roller
- Load Capacity: 4000 lbs
- Pipe Diameter Range: 2" – 48"
- Weight: 140 lbs
- Dimensions: 29" Length, 18" Width, 11.5" Height



**Heavy Duty "HD" Horizontal Pipe Rollers**



**Application:** Heavy duty urethane rollers to help protect coatings on large diameter pipe during river/road crossing installations.

**Additional Features:**

- Angled iron pockets for ease of stacking.
- Fork lift pockets for positioning under pipe and loading on flatbed from all sides.
- 2 lifting eyes.
- Wide footprint and deep "V" pocket secure the pipe for maximum safety.

**Proline 2"-24" HD Horizontal Pipe Roller**

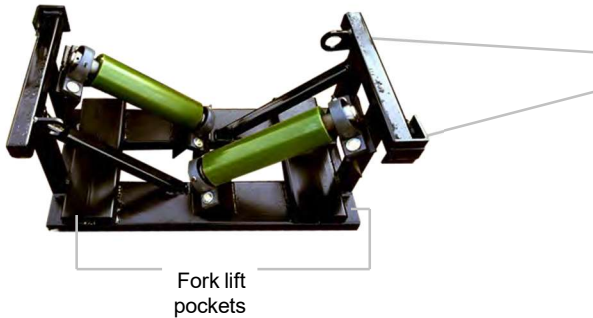

Lifting eye  
Iron pocket (for stacking)

**Load Capacity:** 5,000 LBS.  
**Pipe Diameter Range:** up to 24"  
**Weight:** 215 LBS  
**Foot Print:** 37 1/2" x 19" x 18 3/4"  
(Stackable up to 3 high)

**Proline 2"-30" HD Horizontal Pipe Roller**

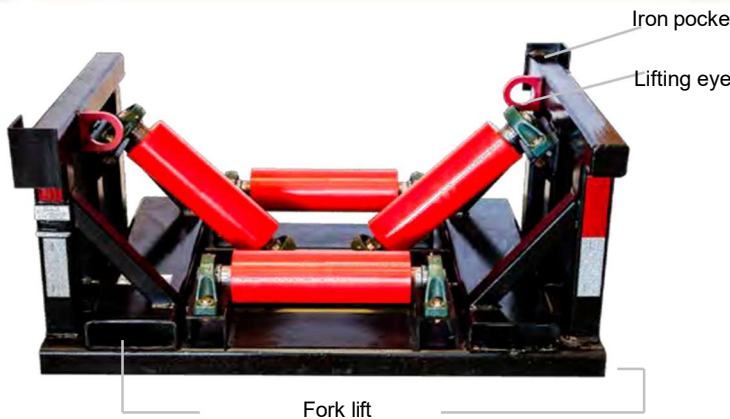

**Load Capacity:** 12,000 LBS.  
**Pipe Diameter Range:** up to 30"  
**Weight:** 655 LBS  
**Foot Print:** 51 1/4" x 32" x 25"  
(Stackable up to 3 high)

## Proline 2"-48" HD Horizontal Pipe Roller



**Load Capacity:** 15,000 LBS.  
**Pipe Diameter Range:** up to 48"  
**Weight:** 1300 LBS  
**Foot Print:** 69 1/4" x 49 1/4" x 29 1/4"  
(Stackable up to 3 high)

## Proline Adjustable 16"-48" HD Horizontal Pipe Roller



**Load Capacity:** 50,000 LBS.  
**Pipe Diameter Range:** 16" to 48"  
**Weight:** 1,605 LBS  
**Foot Print:** 69 1/4" x 37 1/4" x 26 1/4"  
(Stackable up to 3 high)

**Outlaw Padding Buckets**



<p>Dimensions: 55 Inches / 139.7cm</p> <p><b>SMALL</b> Small Buckets attach to: Caterpillar: 315-320 John Deere/Hitachi: 160-210 Komatsu: 160-290 Volvo: 210</p>	<p>Dimensions: 75 Inches / 190.5cm</p> <p><b>MEDIUM</b> Medium Buckets attach to: Caterpillar: 320-329 John Deere/Hitachi: 210-290 Komatsu: 220-290 Volvo: 240-290</p>	<p>Dimensions: 75 Inches / 190.5cm</p> <p><b>LARGE</b> Large Buckets attach to: Caterpillar: 329-349 John Deere/Hitachi: 270-380 Komatsu: 270-390 Volvo: 330-360</p>
--	--	--

All Outlaw Padding Buckets can be pinned, shimmed and bushing to fit all models. Please call for options on other models.

Outlaw's Mechanical Padding Bucket is a non binding, non jamming, non clogging application which turns each and every time on operators demand.

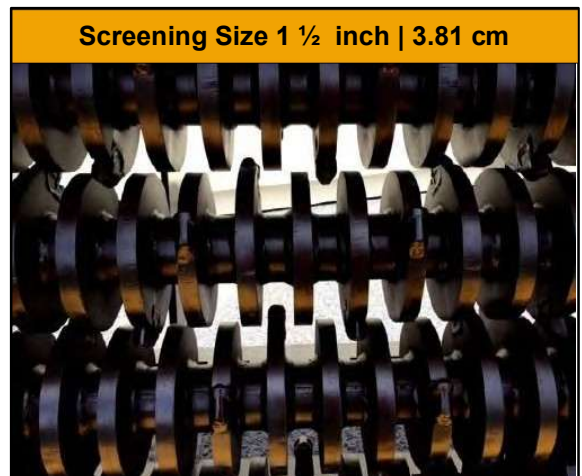
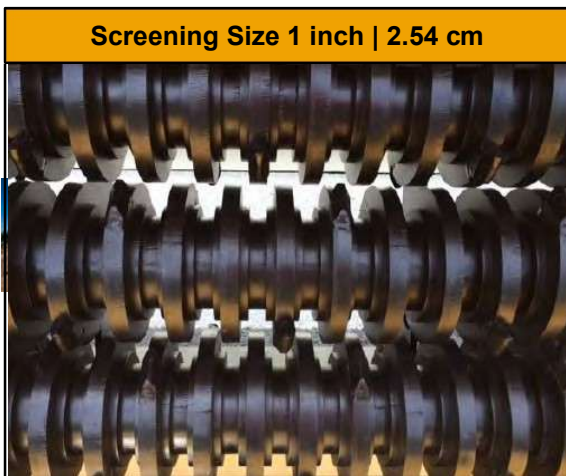

## Nylon Lifting Belt



- Experienced, leading belt manufacturer for over 20 years
- Heavy duty nylon webbing for durability and strength
- Alloy steel end irons for greater strength with less weight
- Web coated with heavy duty Yellow Jacket™ Coating
- Orange vinyl tag with clear protective cover to protect data
- End irons painted
- Custom belts available for pipe diameters not listed
- Belts used around the world, in all types of climates, in sizes up to 60" diameter pipe
- Head iron not included as pictured
- Lowering-in belt and head iron sold separately
- Made in USA
- 5 to 1 design factor standard



## Nylon Lifting Belt Head Iron



- Used to suspend lowering-in belts
- Alloy steel bail for greater strength with less weight
- Painted
- Stainless Steel Data Plate
- Easy release hooks on one side
- Lowering-in Belt not include
- Made in USA

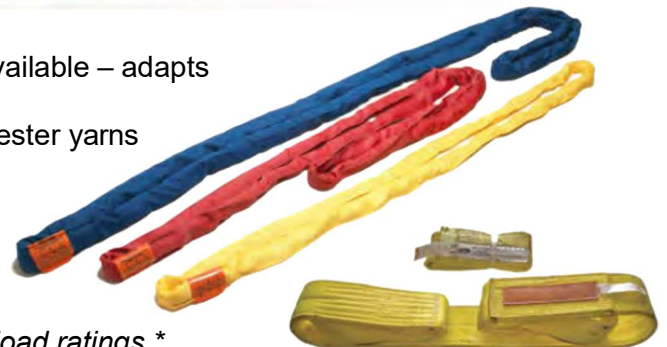

## Round Endless & Web Slings

- Polyester Round Slings are the most flexible sling available – adapts to all types, sizes and load configurations
- Made from extreme load bearing, high strength polyester yarns
- Protected by two woven polyester jackets or cordura that act as a buffer between the load and the yarn – reduces wear
- Web slings available



*\* See next page for load ratings \**

Round Sling Load Ratings

SLINGER POLYESTER ROUND SLINGS											
STOCK CODE NO.	COLOR	 VERTICAL POUNDS	 CHOKER POUNDS	 90° BASKET	 60° BASKET	 45° BASKET	APPROX. DIAMETER INCHES	APPROX. WEIGHT/FT POUNDS	MIN. Connection Hardware Thickness Vertical or Choker (Inches)	MIN. Connection Hardware Thickness Basket (Inches)	MINIMUM LENGTH
SL-30	PURPLE	3,000	2,400	6,000	5,200	4,200	0.75	0.25	0.50	0.62	18"
SL-40	BLACK	4,000	3,200	8,000	6,900	5,600	0.80	0.35	0.50	0.62	18"
SL-60	GREEN	6,000	4,800	12,000	10,300	8,400	0.90	0.40	0.62	0.88	18"
SL-90	YELLOW	9,000	7,200	18,000	15,500	12,600	1.00	0.50	0.75	1.00	2'
SL-120	TAN	12,000	9,600	24,000	20,600	16,800	1.25	0.75	0.88	1.25	3'
SL-140	RED	14,000	11,200	28,000	24,200	19,600	1.30	0.85	1.00	1.38	3'
SL-170	ORANGE	17,000	13,600	34,000	29,300	23,800	1.60	0.95	1.12	1.62	3'
SL-230	BLUE	23,000	18,400	46,000	39,500	32,200	1.65	1.25	1.25	1.75	3'
SL-260	ORANGE	26,000	20,800	52,000	44,700	36,400	1.75	1.45	1.38	1.88	3'
SL-320	GREY	32,000	25,600	64,000	55,000	44,800	2.15	1.75	1.50	2.00	3'
SL-400	ORANGE	40,000	32,000	80,000	68,800	56,000	2.45	2.25	1.62	2.38	4'
SL-540	BROWN	54,000	43,200	108,000	92,900	75,600	3.00	2.75	1.88	2.75	6'
SL-680	OLIVE GREEN	68,000	54,400	136,000	117,000	95,200	3.25	3.60	2.12	3.00	8'
SL-900	BLACK	90,000	72,000	180,000	155,000	126,000	3.75	4.10	2.50	3.50	8'

**⚠ WARNING MAXIMUM RATED CAPACITIES FOR NEW SLINGS. ⚠ DO NOT EXCEED**

SL-540, SL-680, and SL-900 slings are made with an abrasion resistance Nylon Cordura double cover, and therefore when in active chemical environments, the sling user must be aware of which acids might effect the cover or the yarns. (Refer to Chemical chart on Page 7)

SL-230 and SL-320 slings are available with the abrasion resistance Nylon Cordura double cover.

**Measured Length**  
All round slings are measured pull to pull:

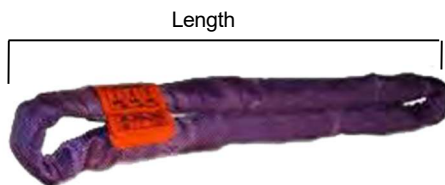

**Round Sling Wear Pad**



It is recommended to always use wear pads

**Pipe Hooks**



- Integrated Handle for Increased Ease of Use
- Made for Long, Hard Service
- Increased Safety Due to Reduced Pinch Points
- Insert Minimizes Pipe Bevel Damage
- Interchangeable Teflon Inserts



Model #	Description	Capacity (Per Hook)	Hook Weight
PH03-06	3"-6" Classic Pipe Hook	1,500 LBS	5 LBS
PH08-24	8"-24" Classic Pipe Hook	8,000 LBS	11 LBS
PH26-48	26"-48" Classic Pipe Hook	13,500 LBS	20 LBS
PH06-16	6"-16" Heavy Duty Pipe Hook	6,000 LBS	11 LBS
PH16-30	16"-30" Heavy Duty Pipe Hook	14,000 LBS	20 LBS
PH48	30"-48" Heavy Duty Pipe Hook	26,000 LBS	34 LBS

Single construction pipe hook with Teflon inserts to protect the pipe bevel. These hooks come in three sizes, each with a 5:1 safety rating. Each hook covers a vast range of pipe diameters. Replaceable Teflon inserts available at a nominal cost

**Plastic Pipestands**



- Lightweight, stackable for easy handling, transportation and storage
- One plastic pipe stand will replace several wooden skids
- Comes in three sizes from 2" to 24"

**2" - 8" Plastic Pipestand**

Overall Height: 21" (53.34 cm)  
Saddle Height: 19" (48.26 cm)  
Weight: 11 lbs. (5 Kgs.)  
Load Capacity: 1,980 lbs. (898 kgs)  
No. Per Standard Pallet: 100



**8" - 12" Plastic Pipestand**

Overall Height: 24" (60.96 cm)  
Saddle Height: 22" (55.88 cm)  
Weight: 18 lbs. (8.17 Kgs.)  
Load Capacity: 3,475 lbs. (1,576 kgs)  
No. Per Standard Pallet: 50



**12" - 36" Plastic Pipestand**

Overall Height: 26" (66.04 cm)  
Saddle Height: 20.5" (52.07 cm)  
Weight: 42 lbs. (19 Kgs.)  
Load Capacity: 13,000 lbs. (5,897 kgs)  
No. Per Standard Pallet: 15



**36" - 48" Plastic Pipestand**

Overall Height: 25" (63.5 cm)  
Saddle Height: 19.5" (49.5 cm)  
Weight: 46 lbs. (20.8 Kgs.)  
Load Capacity: 15,000 lbs. (6,804 kgs)  
No. Per Standard Pallet: 15

*High Temperature Plastic Pipestands also available \**

Proline pipe stands are presently being used successfully for pipeline construction jobs in conjunction with wooden skids for their convenience, economy and ease of handling. These stands have been thoroughly tested and have maximum working load capacities (under ideal conditions) for each model listed below.



Proline pipe stands come in four convenient sizes. The advantages of these pipe stands over wooden skids are their lightweight, ease in handling, transportation, and storage. One plastic stand will replace several wooden skids and one hundred 2-8" pipe stands will fit on a standard 4-foot by 4-foot pallet.

Company names can be engraved or stamped on the stand for inventory control or identification concerns. The saddles are contoured for greater support and for protection of pipe coatings, and each pipe stand is built tough, to withstand the conditions encountered in pipeline construction.

The product is an UV stabilized HDPE (High Density Polyethylene) with an approximate UV life span of 6.5 years. The polyethylene has a melting point of 125°C (257°F) and a low temperature impact resistance of 40°F below (- 40°C). Pigments can be added to produce many different colours if desired. Maximum ambient temperature limit is 98°F (37°C).

The stands are completely recyclable at the end of their useable life and older stands can be tested at different intervals to be culled from old stock if required. Custom sizes are available upon request.

## Hi Temp Plastic Pipestands



Hi-Temp plastic pipestands are available in the same dimensions with same weight ratings as the Yellow Stands (previous page).



A High Temperature WHITE pipe stand is available in all the sizes above and is recommended for environments where ambient temperatures can reach beyond the yellow pipe stand's maximum temperature rating of 98°F ( 37°C ).

Maximum low temperature is 40°F below (- 40°C). Maximum high temperature for this pipe stand is 113°F (45°C). The white color, along with more HDPE material added at the time of manufacturing, makes for higher heat resistant product for only a slightly higher price.

**Discounts are available on Yellow & White Plastic Pipe Stands when 100, 500 and 1000+ are ordered and shipped together.**

**Plastic Cable Stands**



Proline cable stands are presently being used successfully wherever cable support is required. They have been thoroughly tested. Proline cable stands come in two convenient sizes, 20" and 36". The advantages of these stands over other methods of support are their lightweight, ease in handling, transportation, and storage.

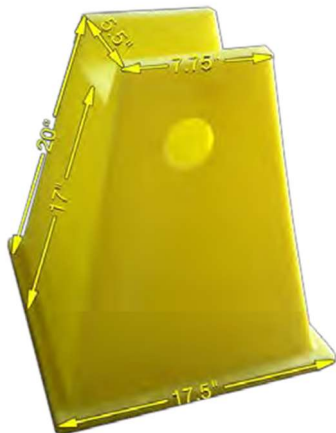

Company names are available upon request for inventory or identification concerns. The cable stands are contoured for greater support. Each cable stand is built tough, to withstand the conditions encountered supporting cable of various sizes.

The product is a UV stabilized HDPE (High Density Polyethylene) with an approximate UV life span of 6.5 years. The polyethylene has a melting point of 125°C (257°F) and a low temperature impact resistance of -40°C (-40°F).

Pigments can be added to produce many different colors if desired. The stands are stackable to allow for economical freight, storage and easy handling.

The cable stands are completely recyclable at the end of their useable life and older stands can be tested at different intervals and can be culled from old stock if required. Custom sizes and colors are available upon request.



20" Plastic Cable Stand	36" Plastic Cable Stand
Yellow Rectangle Shape	Yellow Rectangle Shape
Overall Height: 20"	Overall Height: 36"
Saddle Height: 27"	Saddle Height: 33"
Weight: 8 lbs.	Weight: 14 lbs.
No. Per Standard Pallet: 120	No. Per Standard Pallet: 80

## 30"-48" Plastic Pipe Trench Support



Proline's plastic stackable pipe supports are used to protect the pipe coating. This new and improved design features superior cathodic protection. They hold the 30"-48" pipe and provide support points above the hard/rocky area at the bottom of the trench and protect the pipe's coating, while keeping it off the ground and using minimal labour. These can also be used to keep the pipe off the ground along the right-of-way.

- Size: 30"-48"
- Overall Height: 10"
- Weight: 25 lbs.
- Base: 30.5"x 33"
- Max. Load: 35,000 lbs (15,875 kg.)
- Number on a Pallet: 20



Made of a linear low density polyethylene with UV stabilizers, this product has a life expectancy that exceeds the life of the pipeline that it is supporting. Polyethylene has a melting point of 257°F/125°C and a low temperature impact resistance at -40°F/-40°C.

## Pipe Stringing Chute



The PROLINE Pipe Stringing Chute is designed for safely and easily stringing pipe off the truck trailer onto the ground during pipe stringing. Two roller assemblies mount onto the loaded truck trailer. As the truck slowly moves the pipe is rolled, one at a time, onto the roller assemblies and pushed down the attached chute onto the ground. This process continues until all pipe is removed from the truckload.

Features:

- Accommodates pipe sizes 2" through 8" (50.8mm – 203.2 mm)
- Polyurethane coated rollers and frame to help eliminate pipe-coating damage
- Light weight for easy installation



Solid Tripod Stands

Heavy duty solid  
Pipestands c/w  
positive lock pin



NOTE: All measurements from ground to lowest point of v-head

- HSPS-84 64" tall to 87" tall
- HSPS36** 39" tall to 65" tall
- HSPS30** 34" tall to 56" tall
- HSPS24** 27" tall to 39" tall
- HSPS15** 17-1/2" tall to 25" tall – Custom order only

Rated for max. load of 4000lbs. with appropriate head



The above stands have the following V-Head / Rollerhead options...

VH-6



max. load 4000 lbs.  
XL gusset V-head  
(1/2" up to 6" pipe)

VH-20



max. load 4000 lbs.  
low angle V-head  
(2" up to 20" pipe)

VH-32



max. load 4000 lbs.  
regular V-head  
(2" up to 32" pipe)

RH-4



3" wheels in 4 wheeled  
max. load 1500 lbs.  
max. load 1500 lbs.  
(1" up to 12" pipe)

RH-12



3" wheeled rollerhead  
rollerhead  
(sug. for 1/2" up to  
12" pipe)

RH-24



4" wheeled  
rollerhead  
rollerhead  
(sug. for 1" up to  
24" pipe)  
max. load 2500 lbs.

**Collapsible Tripod Stands**

Collapsible Pipestands c/w positive lock pin  
Rated for max. load of 4000 lbs. with appropriate head

Heavy duty solid  
Pipestands c/w  
positive lock pin

**HCPS-36**



39" tall to 65" tall

**HCPS-30**



33" tall to 55" tall

**HCPS-22**



22" tall to 31-1/2" tall

**HCPS-15**



14-1/2" tall to 28" tall



The above stands have the following V-Head / Rollerhead options...

**VH-6**



max. load 4000 lbs.  
XL gusset V-head  
(1/2" up to 6" pipe)

**VH-20**



max. load 4000 lbs.  
low angle V-head  
(2" up to 20" pipe)

**VH-32**



max. load 4000 lbs.  
regular V-head  
(2" up to 32" pipe)

**RH-4**



3" wheels in 4 wheeled  
max. load 1500 lbs  
max. load 1500 lbs.  
(1" up to 12" pipe)

**RH-12**



3" wheeled rollerhead  
rollerhead  
(sug. for 1/2" up to  
12" pipe)

**RH-24**



4" wheeled  
rollerhead  
rollerhead  
(sug. for 1" up to  
24" pipe)  
max. load 2500 lbs.

**Javelin Collapsible Tripod Stands**



**LPS - Large Pipe Stand**

Range 35" - 55" (890 - 1400 mm)  
Reinforced 8" wide "V" Head (included)  
Wide Stable Tripod Base (collapsible)

Positive Load Locking Pin  
Working Load 5000 lbs



**MPS - Medium Pipe Stand**

Range 29" - 45" (740 - 1143 mm)  
Reinforced 8" wide "V" Head (included)  
Tripod Base

Positive Load Locking Pin  
Working Load 5000 lbs



**SPS - Small Pipe Stand**

Range 16" - 30" (405 - 760 mm)  
Reinforced 8" wide "V" Head (included)  
Wide Stable Tripod Base (collapsible)  
Positive Load Locking Pin  
Working Load 4500 lbs



**LPS-LV - Large Pipe Stand**

(with Leveling Leg)  
Range 35" - 55" (890 - 1400 mm)  
Reinforced 8" wide "V" Head (included)  
Wide Stable Tripod Base (collapsible)  
Positive Load Locking Pin  
Working Load 3000 lbs



**PH-LPS - Powerhouse  
Large Pipe Stand**

Range 36" - 59" (914 - 1499 mm)  
Wide Stable Tripod Base (collapsible)  
Positive Load Locking Pin

Working Load 9000 lbs



**PH-MPS - Powerhouse  
Medium Pipe Stand**

Range 30" - 49" (775 - 1257 mm)  
Wide Stable Tripod Base (collapsible)  
Positive Load Locking Pin

Working Load 9000 lbs



**PH-SPS - Powerhouse  
Small Pipe Stand**

Range 30" - 49" (775 - 1257 mm)  
Wide Stable Tripod Base (collapsible)  
Positive Load Locking Pin  
Working Load 9000 lbs



**V8 - 8" "V" Head**

Reinforced 8" wide "V" Head  
Designed for standard Javelin  
pipe stands.

\* will not work with Powerhouse  
pipe stands



**PH-HD32V - 32" "V" Head**

Heavy duty reinforced "V" Head for up to 32"  
wide pipe

\* Designed for Javelin PH (Powerhouse)  
pipe stands



**HD18V - 18" "V" Head**

Reinforced 18" wide "V" Head  
Designed for Javelin pipe stands

\* will not work with Powerhouse  
pipe stands



**PH-HD36V - 36" "V" Head**

Heavy duty reinforced "V" Head for up to 36"  
wide pipe

\* Designed for Javelin PH (Powerhouse)  
pipe stands



## Javelin Rollerheads

Extra care is taken to make sure the wheels of our pipe rollers are perfectly aligned. They are built with extra solid frames, quality bearings, wide wheels and long wheel bases for true tracking. A well designed pipe roller makes it much easier for welders to get a smooth bead and to do it safely.



### PR112 - 12" Pipe Roller

Best for 1"-12" pipe  
Four 3" steel or polyurethane wheels  
Very stable pipe roller  
Adjustable height  
Designed for Javelin pipe stands  
Working Load 2500 lbs



### MIR - 24" Multi-use Industrial Roller

12" wide roller  
Level and move heavy pieces into a drill press  
Great for feeding steel into a saw  
Adjust roller guides to allow rolling of wide sheets



### PR212 - 12" Pipe Roller

Best for 1"-12" pipe  
Two 3" steel or polyurethane wheels  
Compact and versatile  
Easily adjust to three different wheel settings with wing nuts  
Designed for Javelin pipe stands  
Working Load 2500 lbs



### PR236 - 36" Pipe Roller

Best for 2"-36" diameter pipe  
Two 6" steel or polyurethane wheels  
Remove wheels and you have a tough V-head  
Easily adjust to four different wheel settings with wing nuts  
Designed for Javelin SH236 sawhorse stand  
Also designed to fit on two Javelin LPS  
Working Load 6000 lbs



### PR220 - 20" Pipe Roller

Best for 1"-20" pipe  
Two 4" steel or polyurethane wheels  
Compact and versatile  
Easily adjust to four different wheel settings with wing nuts  
Designed for Javelin pipe stands  
Working Load 2600 lbs



### PH-PR230 - 30" Pipe Roller

Best for 1"-30" diameter pipe  
Two 5" steel or polyurethane wheels  
Remove wheels and you have a tough V-head  
Easily adjust to four different wheel settings with wing nuts  
Designed for Javelin PH pipe stands  
Working Load 6000 lbs



### MPR24 - 24" Multi-directional Pipe Roller

Best for 2"-24" diameter pipe  
Two superior quality, hardened stainless steel roller balls to ensure smooth roll in all directions  
Easily adjust to four different wheel settings with wing nuts  
Designed for Javelin pipe stands  
Working Load 2600 lbs



### PR24-72 - "Big Hoss"

Automatically adjusts to pipe size  
Best for pipe 24"-72" (61-183cm)  
Height adjustment range 4.5"  
Height 16.5" - 21", Width 42", Length 53"  
Outrigger pads swivel and tilt  
Stackable for compact hauling and storage  
Working load 11,000 lbs (4990kg)



Sawhorse Stands



Javelin SH236 - Sawhorse Stand

Designed for PR236 (36" pipe roller)  
Range 31"-46" (787-1168 mm)  
Positive load locking pins (must be used at all times)  
Centre adjustment for coarse adjustment (only to be used without load)  
Handy wheels for use when moving into location (no load)  
Working Load 6000 lbs



Javelin SH236 Stand with Javelin PR236 Rollerhead

Adjustable Heavy Duty Pipe Rollers

RH-36



available in 4000 & 5000 lb ratings.  
(sug. for 2" to 36" pipe)

RH-48



available in 4000, 5000 & 10,000 lb ratings  
(sug. for 2" to 48" pipe)



Sawhorses

SH-36

sawhorse 36"L x 28"H  
3" x 3" x 1/4" wall sq. tubing top beam  
max. load 4000 lbs

SH-48

sawhorse 48"L x 28"H  
3" x 3" x 1/4" wall sq. tubing top beam  
max. load 5000 lbs.



## Pipe Dollies

### "Grasshopper" Pipe Dolly

- Enables one man to lift 2,000 lb (900 Kg) unassisted!
- Special sliding chain block design accommodates long and short loads
- Carries up to 20" (500 mm) diameter pipe, tool boxes, fittings and valves
- Fits through 35" (89 cm) openings, is a versatile 12 feet (3.6 m) long and weighs only 165 lbs (75 kg)
- Rugged high pressure tires and wheels allow for construction site mobility
- Chains can be used to lock wheels for security



### "Cricket" Pipe Buggy

- Transport 20 ft (6.1 m) pipe lengths up to 1,000 Lb. (450 Kg)
- Comes with ratchet hold-down strap and 16" (41 cm) tubed tires.
- Weighs only 82 Lb (37.2 kg) ... can be shipped U.P.S.
- Quick handle disconnect for compact storage.
- Carries up to 12" (300 mm) diameter pipe.
- Ideal job-site material carrier.



1) Use ratchet to secure Cricket to pipe



2) Reposition handle



3) Use handle to flip Cricket & pipe

### Pipe Cart

- Transports 2,000 lb (900 kg) of pipe, individually or up to a height of 34" (86 cm)
- Six 6" heavy duty casters
- Center-positioned casters makes rolling the Pipe Mac easy and enables quick cart rotation for tight turns
- Posts pull out for compact storage
- Stacks when not in use



Simple but rugged attachment prevents pipe from rolling while the Pipe Mac is in motion. Easily slips over the four post holders -- no tools required!

Compact Storage & Stacking!



## DECKHAND LaValley Excavator Attachments



Engineered around optimal safety, the DECKHAND® by LaValley Industries allows precise load handling and placement without the need for a ground crew working in the vicinity of moving pipe, poles or road mats. DECKHAND® is designed to work safely in any weather condition, including wind, mud, snow and ice.



The DECKHAND® system is a modular design that consists of a main head unit used with a variety of interchangeable arms. The main head mounts to any brand of excavator—the excavator's auxiliary hydraulics then safely and efficiently power the DECKHAND® system. The interchangeable arms are used to pick up pipe, poles, casings or road mats and securely lift, lower, rotate, and tilt the load under the total control of the operator. Arms can grip securely from an off-center position, allowing maximum control in areas with tight accessibility.

Achieve controlled, 360° precision material handling—whatever the conditions—with DECKHAND®.



- Head Unit mounts to any brand of excavator.
- 360° Continuous Rotation
- In-Cab display allows operator to safely monitor and adjust all functions, working parameters, and hydraulic settings from inside the excavator or prime mover.
- Designed with load holding valves so that pipe is held securely regardless of hydraulic pressure.
- Powered by the auxiliary circuit on excavator or prime mover.
- Can handle pipe covered with snow, ice or dirt.

## Vacuworx Vacuum Lifting System



Vacuworx offers the most comprehensive line of heavy-duty lifting and material handling systems on the market. Our innovative vacuum lifting technology is the safest and fastest method for handling pipe, plate, slab and concrete road barriers.

Vacuworx Lifting Systems are designed for the energy, water and sewer, and road construction industries, as well as airport rehabilitation, in-plant industrial facilities, port facilities, pipe mills, and storage yards.

Uncover a faster, safer and smarter material handling solution with the confidence of Vacuworx Lifting Systems in your field of work today.

### Benefits of Vacuworx Lifting Systems

- Requires half the number of ground personnel vs. conventional methods.
- Allows project start-to-finish times to be cut by as much as half.
- Removes ground personnel from hazardous work conditions.
- Eliminates the need for unsafe lifting mechanisms such as hooks, chains, or slings.
- Handles a variety of materials with no damage to materials or coatings.

### Features

- Hydraulic rotator allows for 360 degree rotation.
- Fully self-contained lifters
- Readily interchangeable vacuum pads with quick fittings for different materials.
- Materials can be stockpiled without spacers.
- Operates by wireless remote with optional hard wire control.
- Meets or exceeds ANSI/ASME standards section B30.20, ASME BTH-1, and AS 4991.
- CE Certified and OSHA Compliant.
- Visible and audible alarms warn against low vacuum.
- Replacement parts and service available for all products.

Lifters can be attached to hydraulic excavators, backhoes, wheel or track type loaders, cranes, pipelayers, forklifts, knuckle booms and numerous in-plant applications.



**Efficient**

- Lifters increase productivity by 7-12 times during load and unload cycles.
- Vacuum pads have quick fittings and readily interchange to allow for different materials.
- A 360° hydraulic rotator.
- Lifters are fully self-contained.
- Materials can be stockpiled without spacers.
- Lifters operate by wireless remote control.



**Safe**

- Fewer ground personnel reduces the risk of accident.
- Meets or exceeds ANSI/ASME standards section B30.20, ASME BTH-1, and AS 4991.
- CE Certified and OSHA Compliant.
- Lifts most types of coating with no damage to materials or coatings.
- Visible and audible alarms warn against low vacuum.

**Economical**

- Fewer ground personnel required means lower payroll costs.
- In some applications certain types of pipe can be joined without additional ground crew.
- Much quicker and therefore more economical than pipe hooks, pipe forks or pipe tongs.
- Replacement parts and service available for all products.

**Vacuworx Spec's**

Lifter	Lift Capacities	Pipe Diameter	Dimensions (with Adaptor)
<b>RC-10</b>	22,000 lb (10 tonne)	Pipe from 4" to unlimited diameter, single or double joints	Length 103" Height 77" Width 21" Weight 2,132 lb
<b>RC-12</b>	26,400 lb (12 tonne)	Pipe from 4" to unlimited diameter, single or double joints	Length 103" Height 77" Width 21" Weight 2,132 lb
<b>RC-16</b>	35,200 lb (16 tonne)	Pipe from 4" to unlimited diameter, single or double joints	Length 103" Height 77" Width 21" Weight 2,397 lb



## MatJack Air Lifting Bags

Use MatJacks under the most adverse conditions to re-locate position and align heavy machinery and odd-shaped loads. MatJacks air lifting bags are used anywhere there's a heavy object to lift or move.



- MatJack's unique construction of four full layers of Aramid Fiber or three full layers of woven steel, provide for a lifting bag unequalled in strength and durability.
- All MatJack air lifting bags are marked with a distinct white numbered, "bulls eye" for ease of centering under the load, and have a conical, interlocking surface to limit slippage and aid in stacking.
- All MatJacks have either carry handles or tabs molded right on for lifting or attaching to fixtures.
- The MatJack "state-of-the-art" deadman controller allows for independent or simultaneous operation of one or more airbags.
- Supply hoses are color coded to help eliminate confusion during simultaneous operation of more than one air bag.
- Available in a variety of sizes and ranging in lifting capacity from 1.5 tons to 86 tons, the MatJack air lifting bag system is efficient and economical, safe and reliable, making them simply the best.



## MatJack Accessories

High Pressure Supply Line (available in 6 colors)



515 20' High Pressure Supply Line - 20' / 6 meter high pressure supply hose



515SC 20' High pressure supply hose with safety couplers - 20' / 6 meter high pressure supply hose with safety couplers



515SR 20' Safety relief hose - 20' / 6 meter high pressure safety relief hose



Dual Push Button Deadman control with 120 psi/8 bar relief valve used to control inflation and deflation with one common air source of Matjack high pressure air lifting bags, come standard with two 0-160 psi/10 bar gauges.



515SRSC 20' Safety relief hose with safety couplers - 20' / 6 meter high pressure safety relief hose with safety couplers



10 ft / 3 m Regulator hose primarily for use with bottle regulators to connect regulator to control unit.



Inline Relief Valve

MatJack Air Lifting Bag Specs

<b>MATJACK HIGH PRESSURE AIR LIFTING BAG SPECIFICATIONS</b>										
PART #	MODEL	MATERIAL TYPE	DIMENSIONS IN CM	CAPACITY US TONS METRIC TON	LIFTING HEIGHT IN CM	WEIGHT LBS KG	MAX WORKING PRESSURE	SHAPE	HANDLES TABS WITH EYELETS	VOLUME - AIR CU. FT./ LTR
101K	1.5 TON	ARAMID	6 x 6 x .75 in. 15.24 x 1 5.24 x 1.9 cm.	1.5 1.3	2.5 6	2 0.9	120 psi 8 bar	SQUARE	2 TABS	0.2 6.3
103K	3.3 TON	ARAMID	6 x 12 x .75 in. 15.24 x 30.48 x 1.9 cm.	3.3 2.9	3 7	3 1.3	120 psi 8 bar	RECTANGLE	4 TABS	0.44 12.66
106S	6 TON	STEEL	10 x 10 x 1 in. 25.4 x 25.4 x 2.54 cm	6 5	4.5 11	6 2.7	120 psi 8 bar	SQUARE	4 TABS	0.68 19.3
106K	6 TON	ARAMID	10 x 10 x 1 in. 25.4 x 25.4 x 2.54 cm	6 5	4.5 11	4 1.8	120 psi 8 bar	SQUARE	4 TABS	0.68 19.3
113S	13 TON	STEEL	15 x 15 x 1 in. 38.1 x 38.1 x 2.54 cm.	13 11	7.5 19	15 6.8	120 psi 8 bar	SQUARE	4 TABS	2.7 76.4
113K	13 TON	ARAMID	15 x 15 x 1 in. 38.1 x 38.1 x 2.54 cm	13 11	7.5 19	11 4.9	120 psi 8 bar	SQUARE	4 TABS	2.7 76.4
115S	15 TON	STEEL	15 x 21 x 1 in. 38.1 x 53.34 x 2.54 cm.	14.8 13.5	7.5 19	19 9	120 psi 8 bar	RECTANGLE	2 TABS 1 HANDLE	3.48 98.6
115K	15 TON	ARAMID	15 x 21 x 1 in. 38.1 x 53.34 x 2.54 cm.	14.8 13.5	7.5 19	15 7	120 psi 8 bar	RECTANGLE	2 TABS 1 HANDLE	3.48 98.6
122S	22 TON	STEEL	20 x 20 x 1 in. 50.8 x 50.8 x 2.54 cm.	22 19	9.5 24	28 12.7	120 psi 8 bar	SQUARE	1 HANDLE	6.67 189
122K	22 TON	ARAMID	20 x 20 x 1 in. 50.8x 50.8 x 2.54 cm.	22 19	9.5 24	22 9.9	120 psi 8 bar	SQUARE	1HANDLE	6.67 189
132S	32 TON	STEEL	21 x 25 x 1 in. 53.34 x 63.5 x 2.54c m.	32 29	12 30	35 15.8	120 psi 8 bar	RECTANGLE	1 HANDLE	11.58 328
132K	32 TON	ARAMID	21 x 25 x 1 in. 53.34 x 63.5 x 2.54 cm.	32 29	12 30	28 12.7	120 psi 8 bar	RECTANGLE	1 HANDLE	11.58 328
137S	37 TON	STEEL	42 x16 x 1 in. 106.68 x 40.64x2.54 cm.	37 34	9 22	43 19.5	120 psi 8 bar	RECTANGLE	7 TABS 2 HANDLE	13.3 375.8
137K	37 TON	ARAMID	42 x 16 x 1 in. 106.68 x 40.64 x 2.54 cm.	37 34	9 22	33 14.9	120 psi 8 bar	RECTANGLE	7 TABS 2 HANDLE	13.3 375.8
150S	50 TON	STEEL	29 x 29 x 1 in. 73.66 x 73.66 x 2.54 cm.	50 45	15 38	63 28.5	120 psi 8 bar	SQUARE	2 HANDLE	19.78 560
150K	50 TON	ARAMID	29 x 29 x 1 in. 73.66 x 73.66 x 2.54 cm.	50 45	15 38	45 20.4	120 psi 8 bar	SQUARE	2 HANDLE	19.78 560
170S	70 TON	STEEL	34 x 34 x 1 in. 86.36 x 86.36 x 2.54 cm.	70 63	18 45	81 36.7	120 psi 8 bar	SQUARE	2 HANDLE	37.5 1062
170K	70 TON	ARAMID	34 x 34 x 1 in. 86.36 x 86.36 x 2.54 cm.	70 63	18 45	60 27.2	120 psi 8 bar	SQUARE	2 HANDLE	37.5 1062
186S	86 TON	STEEL	42 x 42 x 1 in. 106.68 x 106.68 x 2.54cm	86 78	24 60	118 53.6	120 psi 8 bar	SQUARE	4 HANDLE	57 1616

**Pipe Puller**

This tool was conceived by welders and pipe fitters, for welders and pipe fitters. It has taken a cumbersome and time consuming procedure and drastically simplified it, especially in confined workspaces, such as oil and gas facility construction.

Existing methods require a lot of gear and a lot of space to perform this task, along with the inherited safety issues. Developed around the same principles as existing methods, except faster, more ergonomic and safer. Requiring very little room for clamping up, a single tool and package to perform the majority of work and most importantly, drastically reducing failure risk and consequences.

- A faster, safer and more ergonomic way to push and pull pipe
- Built for field use
- A small package for easy transport and hoisting
- Non pipe size specific
- What's needed for rigging is always in place
- Designed for use in limited spaces
- Allows for access to joint during fit-up
- Pipe can be fit and ready for welders
- Can be left in place while welding

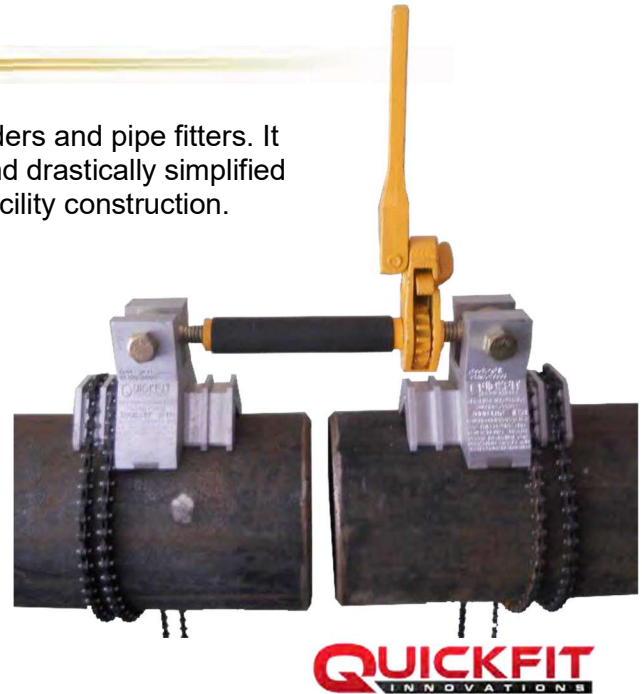

**Time Savings**

This graph/chart is an illustration of the time saving numbers (from low to high estimates) that were given to QuickFit Innovations from industry personnel. We have used a \$60/hour rate of pay and used an average joint count estimate of 3 joints per day for graphing and chart purposes.

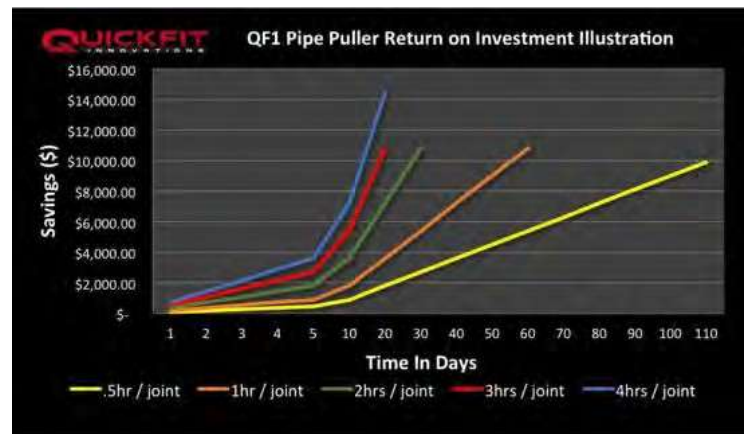

**Technical Specifications:**

- Safe Working Load (SWL): 5000 lbs. (2.25 tonnes)
- Jack Shear Strength: 72000 lbs. (32.6 tonnes)
- Pin/Bolt Shear Strength: 23000 lbs. (10.4 tonnes) x2
- Jaw Ear Shear Strength: 62000 lbs. (28.1 tonnes) x2
- Clamping Force (Min-Max): 18000-24000 lbs. (8.1-10.8 tonnes) x2

## Gen Set and Induction Heating Coils



### Gen Set

- Self contained skid-mounted unit
- 120 kVA & 150kVA high frequency generators
- Diesel powered air cooled engine
- Auxiliary power sourced
- Electronic specifications display
- Remote controlled



### Coils

- Heavy duty electrical system
- Clam-shell design allows easy access to weld
- Rolls easily on the pipe
- Easy open and shut
- Light Weight
- Available sizes: 6", 8", 10", 12", 16", 20", 24", 30", 36", 42", 48"



## Renwrap®

Renwrap can be applied over a wide range of temperatures with good adhesion on both plastic and F.B.E. pre-coated pipe

### General Utility Tape

#### Renwrap #300

- Renwrap #300 is a black low density polyethylene film, calendered with a rubber adhesive..
- Can either be applied by hand or machine to achieve uniform, consistent tension, particularly at welded joints
- Can be applied over a wide range of temperatures
- Exhibits good adhesion to plastic and F.B.E. pre-coated pipe

#### Renwrap #330

- Renwrap #330 is a heavy duty joint and handwrap coating tape.
- Designed for handwrapping field joints, fittings, ells and tees and is compatible with coal tar, fusion bond epoxy, asphalt and polyethylene pipeline coatings
- Can be applied over a wide range of temperatures

#### Renwrap #327 Primer

- RENWRAP 327 is a primer recommended for use on all hand brush applications with RENWRAP pipeline coatings.
- It can also be used in machine applications to rough, reconditioned surfaces where a higher solids content is needed.



## Royston Mastics®

- High performance coatings that have excellent resistance to cathodic disbondment
- High electrical resistivity
- Easy to apply, fast setting and low cost



## Polyguard

RD-6 pipeline corrosion coating is a system that allows cathodic protection currents to reach any disbonded area which occurs on the pipeline.

- RD-6™ is a non-shielding coating. This means that if the coating ever becomes disbonded, the pipeline is still protected because cathodic protection currents can reach the disbonded area. Once there, the current will raise the pH of the water underneath the disbonded area to 9 or higher – a level too high to support corrosion. Additionally, the geotextile fabric backing of RD-6™ does not shield cathodic protection currents.
- RD-6™ is less likely to fail (to become disbonded) because:
  - RD-6™ resists disbondment from the pipe, even if surface preparation is less than perfect.
  - RD-6™ is highly resistant to soil stress, a major cause of coating disbondment.
  - RD-6™ installs faster than almost any other coating, and requires no cure.
- RD-6™ is not a tape. North American pipeline operators have virtually banished solid film backed tapes and shrink sleeves. RD-6™ is quite different.
- RD-6™ has a long record of successful installations in the field.



## Tapecoat® Protective Coatings

Protective coatings recommended wherever corrosion and abrasion are a problem on steel, wool and concrete surfaces.

### TAPECOAT® H50 Gray™

- A new technology that features a cold-applied tape with multiple-alloy polymers for use both above and below ground
- Designed to protect pipe from corrosion and electrolysis
- With an integrated primer, Tapecoat H50 Gray is resistant to UV rays, thermal expansion, impact and abrasion
- Liquid primer not required



### TAPECOAT® CT 10/40W

- A 50 mil cold applied tape coating for in service temperature of 120°F. (48.89°C)
- It is used for coating pipe, pipe joints, fittings, couplings, tanks, cable and other metal surfaces.
- Application can be by hand or machine while removing the release liner and spirally wrapping with a minimum overlap.

## Denso® Tapes and Primers

- Complete corrosion protection system with sealant and waterproofing system
- Formulated from petrolatum in the form of pastes, mastics and impregnated tapes and cords
- Cold applied, pliable, durable and easy to apply

### Denso LT Tape

Denso LT Tape is composed of a non-woven synthetic fabric carrier, fully impregnated with a neutral compound based on saturated petroleum and inert silicious fillers.

Denso LT Tapes are specifically designed for applications at cooler ambient temperatures.

The tapes provide long term corrosion protection to pipes, flanges, valves and related surfaces.

### Denso Hotline Tape

Denso Hotline Tape is composed of a synthetic fabric impregnated with a special blend of high temperature petrolatum, mineral fillers and thermal extenders.

A specifically developed tape for use in high temperature applications. Ideal for pipe work above or below ground, underneath pipe insulation or for pipes laid in concrete.

### Denso Paste

Denso Paste is a soft brown petrolatum primer containing moisture displacing corrosion inhibiting compounds for application by stiff brush or gloved hand at normal ambient temperature. It does not dry, harden or crack.

Primarily used as a primer prior to the application of Denso petrolatum tapes. Denso Paste will penetrate existing rust, displace moisture, pacify the surface and aid the adhesion of petrolatum tapes and mastics. It is also used as a temporary coating for exposed metal.

### Denso Profiling Mastic

Denso Profiling Mastic is a cold applied self-supporting molding mastic. It is a petrolatum compound containing beads of closed cell cellular polymer and flow control additives.

The mastic is used to provide a smooth profile on irregular shaped fittings such as flanged joints and valves. It is applied prior to the tape application and generally used in conjunction with primer, Denso Petrolatum Tapes or Denso Bituminous Tapes.



## Tuff-N-Nuff Rockshield

TUFF-N-NUFF Rock Shield is a non-woven mat consisting of small diameter (approximately 0.050") strands of flexible PVC. The strands are bonded to each other in a controlled, random pattern. TUFF-N-NUFF Rock Shield protects pipe coatings from direct impact during backfilling operations. It also provides long term protection by keeping hard objects in the backfill away from the pipe coating during operation of the line. TUFF-N-NUFF protects the pipe coating from these abrasive objects as lateral and longitudinal movements occur.

### Features:

- Can withstand temperatures of 350°F
- Tear strength of 15 lb./inch
- Does not inhibit cathodic protection
- Choose from pads or rolls



Pipe Diameter	Standard Roll Width	Linear Ft./Roll
2"	24" (cut in half)	60
3"	36" (cut in half)	60
4"	36" (cut in half)	60
6"	24"	30
8"	36"	30
10"	36"	30
12"	44"	30

\* 72" Rolls also available

\* Rolls can be cut into pads for larger diameter pipe

### 3M™ Scotchkote™ Fusion-Bonded Epoxy Coating 134

3M™ Scotchkote™ Fusion-Bonded Epoxy Coating 134 (FBEC) is a one part, heat curable, thermosetting epoxy coating designed for corrosion protection of metal. Meets NSF 61 for drinking water.

3M™ Scotchkote™ Fusion-Bonded Epoxy Coating 134 is a one-Part, heat curable, thermosetting epoxy coating designed for corrosion protection of metal. The epoxy is applied to preheated steel as a dry powder which melts and cures to a uniform coating thickness.



### 3M™ Scotchkote™ Liquid Epoxy Coating 323, Brush Grade

3M™ Scotchkote™ Liquid Epoxy Coating 323, Brush Grade can be used as a patch material and a girthweld coating in a wide variety of other field applications where corrosion protection of metal is required.

This is a 2 Part liquid epoxy kit suitable for brushing used for patching pipe coatings. Each Part (Part A and Part B) comes in a quart sized container. It can be used as a patch material, a girthweld coating, a stand alone coating for pipe rehabilitation, and in a wide variety of other field applications where corrosion protection of metal is required.



### 3M™ Scotchkote™ Patch Stick 226P, Green, 5 lb.

3M™ Scotchkote™ Hot Melt Patch Compounds are heat bondable polymeric coatings in stick form designed for plant and field repair of Scotchkote Fusion Bonded Epoxy Coatings. Scotchkote Hot Melt Patch Compounds are ideal for repairing minor pinholes and abrasions. The compounds are color matched to Scotchkote Fusion Bonded Epoxy Coatings. Scotchkote 226P Green is matched to Scotchkote 226N and 6233 coating.



## Canusa K-60 Shrink Sleeves



### One-piece heat-shrinkable sleeve with pre-attached closure

The Canusa K-60 Wraparound sleeve is designed for corrosion protection of buried and exposed pipelines operating up to 60°C (140°F). K-60 consists of a cross-linked polyolefin backing, coating with a technologically advanced corrosion protective adhesive, which effectively bonds to the steel substrates and common pipeline coatings including polyethylene and fusion bonded epoxy.



## Canusa Wrapid Tape™

### Primerless cross-linked Protective Tape

Canusa Wrapid Tape™ consists of a cross-linked polyolefin backing, coated with a protective, heat activated anti-corrosion adhesive which effectively bonds to steel substrates and common pipeline coatings including polyethylene and fusion bonded epoxy.



## TBK (Thrust Bore Kits)

### Multi-Layer Sleeve and Epoxy System For Directional Drilling

Canusa-CPS's TBK - Directional Drilling Kit is a high performance system designed to protect welded joints on 2 and 3-layer PE, PP and FBE coated pipelines in directional drills. The system consists of three components: a primary heat-shrinkable sleeve which provides corrosion protection at the joint; a secondary heat-shrinkable sleeve which functions as a sacrificial wear cone; and a high-build epoxy top coat or fiberglass reinforcement at the ends to provide additional protection to the system.



## HBE-95

### Superior Corrosion Protection up to 95°C

The Canusa HBE-95 is an advanced two-component epoxy coating system which has been specifically formulated for pipelines worldwide. Applied to bare steel, HBE-95 has proven to withstand operating temperatures up to 95°C (302°F) with superior performance. HBE-95 is used for protection of pipeline field joint girth welds, valves and fittings, as a holiday repair material on FBE coated pipe or for pipeline coating rehabilitation projects. This environmentally friendly, 100% solids, novolac epoxy system can either be spray applied or brush applied to the intended substrate.



## E-Primer



### Force-cure epoxy for superior 3-layer corrosion protection

Canusa Liquid Epoxy Type E is a force cured, two part epoxy used as the primary layer with Canusa 3-layer systems, such as GTS-PE and GTS-65. Usage of Canusa's proven method of force curing enables the installer to "pre-inspect" the joint prior to sleeve application. This provides the assurance that the pipe is fully protected and it will not be displaced and exposed to corrosive contaminants during the aligning and shrinking stages of the sleeve installation. It is composed of a specially formulated 100% solids epoxy system, which does not use any volatile solvents. This ensures that the thickness of the epoxy layer does not change as it cures.



## GTS-PE

### Factory Grade™ 3LPE Field-Applied Coating System

The GTS-PE 3LPE coating system is the World's first heat recoverable coating system designed with Factory Grade™ 3LPE materials, delivering equivalent performance to the factory-applied 3LPE coating. Compared to other Factory Grade™ 3LPE coating systems, GTS-PE provides very low installation temperatures and a proven, uniform and repeatable application process.



**INR-110**



**Corrosion protection and sealing sleeves for pre-insulated pipe joints**

Canusa provides high performance, heat shrinkable products designed for the corrosion protection (INR-110) and sealing protection (KTG/KLG, KTS/KLS, KTON, SuperSeal™, GTS-65) of pre-insulated pipe joints.

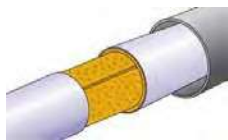

Proline stocks an inventory of Half Shell insulation 1"-2" thick for pipe sizes ranging 2"-16" diameter.

**Coating Repair Products**

**Mainline coating repair products for corrosion protection**

Mainline coating repair products including melt sticks, fillers and repair patches compatible with common pipeline coatings.

**MS (Melt Stick)**

- Easy-to-apply rod of heat-activated hot-melt adhesive

**MF (Fillers)**

- A quick fill for voids or crevices prior to patch application

**CRP (Coating Repair Patches)**

- A broad range of operating temperature specific and soil stress resistant adhesives for project specific conditions

**HBE Repair Pack - 50mL**

- A small & convenient field ready kit complete with gloves and applicator sponge. Mix the HBE inside the two-chamber disposable bubble package and apply when ready. It is the fastest and easiest repair installation available.



**HBE Repair Cartridge - 400mL**

- The repair cartridge is available with an HBE Cartridge Dispenser and Disposable Mixing Nozzle. Apply the HBE directly to the intended substrate with the Mixing nozzle or dispense into a mixing cup before application.

\*Call Proline for information on any Canusa product not found in catalog.



## Paint / Chip Brushes and Cage Rollers

These paint brushes and rollers are used in the pipeline industry for the application of 2-part epoxy on girth welds. Others use a glue that is injected once and the bristles/synthetic filament (hairs) are combed, maybe, once. The result is, hairs fall out. Usually the competition uses a 50/50 or 70/30 mix of synthetic filament to pure bristle (boar hair)

### Brushes:

Our brushes are pure synthetic filament or pure boar bristle. The hairs of both are injected twice with epoxy, making them well seated. The hairs are combed twice. The process ensures a minimal chance of hairs breaking free from the brush and contaminating the coating. Also, our brushes are very ergonomic and light weight. Comes in 2" and 4".

The only functional difference between the two is that bristle brushes can be used with thinners. Synthetic filament cannot. Some say the synthetic filament gives a smoother, more even finish. Besides that, it's a matter of preference. Comes in 4".

### Rollers:

Our rollers are 7" or 9" wide. FBE cutbacks on pipe ends are commonly 5" wide. There is a common requirement for a 2" overlap onto the FBE coating. Our size allows one to run the roller along side the GW bead without rolling atop of it (which removes coating from the bead and causes coating to be too thick right beside the bead) while not over coating too much of the FBE.

Our nap of 6mm works very well with the consistency of Common pipeline epoxy coatings, giving a very smooth and even finish. In practice, it seems to be the best nap size for GW coating.



## J-Rollers

Gives 30-40 PSI for positive bonding. The 1-1/2" diameter x 3" wide rubber roller has no axle projection on one end, for scratchless flush work. The handle is 1/2" diameter sturdy lightweight aluminum alloy, and has two soft vinyl hand grips. Available in black and white roller colors and both are nonmarking. Overall length is 12-1/2" and weighs 1/2 lb.



## Vapor Propane Torches

Turboroofers One-Piece Detail Torch Assembly with stand. Sievert Pro 88 handle, 7" steel neck tube, 2" brass burner.



Product Data	
Length	18"
Weight	1.4 lbs
Head Diameter	2"
Flame Length	20"
Max. Capacity BTU/hr @ 28/57 PSI	175.000/300.000
Gas Consumption lbs/hr @28/57 PSI	8.8/14.7

## Sievert HK 1-30 Hot-Air Detail

### No Exposed Flame!

- For Detail Work and Drying
- Provides "Controlled" Heat to Membranes APP and SBS
- Convenient Piezo Ignition with Dead Mans Grip
- Light, Ergonomic and Well Balanced
- Runs off **Liquid Propane!**
- Especially good for detail work and heating Peel-N-Stick membranes.

### HAK1-30 Kit Includes

2981-38 hot-air welder, hose, regulator and quick connect set.



## Vapor Propane Hoses, Regulators, and Tanks

### Fisher 67CH Regulator

Suitable for liquid or vapor service, this regulator can be used for a variety of applications - torches, heaters, flame cultivators, appliances, etc.

### Type I Hose

- CSA approved to CGA standards 8.1 or 8.3.
- Used for the transfer of Natural Gas in a vapor state and Propane in a vapor or liquid state up to 350 PSI.
- Type 1 Hose Assemblies are available in 1/4", 3/8", 1/2" & 3/4" I.D.
- Fitted for Vapor and Liquid propane applications.



## Liquid Propane Hoses, Regulators, and Tanks

### Liquid and Vapor Propane Bottles

### FT6 - Tiger Torch

2 ft. Handle  
700,000 BTU

- Ideal torch where high output is required
- Allows full use of fuel in propane cylinder
- Commonly used in a preheating applications.
- Works equally as well to quickly clear snow, ice and moisture from the pipe.



### Pin Wheel Heaters

Designed for pre-heating the pipe internally.  
Burners spin freely for even heat distribution.  
Designed and fabricated for your specific preheating needs.



### Fisher 67CH Regulator

Suitable for liquid or vapor service, this regulator can be used for a variety of applications - torches, heaters, flame cultivators, appliances, etc.



### **Type I Hose**

CSA approved to CGA standards 8.1 or 8.3.

Used for the transfer of Natural Gas in a vapor state and Propane in a vapor or liquid state up to 350 PSI.

Type 1 Hose Assemblies are available in 1/4", 3/8", 1/2" & 3/4" I.D.  
Fitted for Vapor and Liquid propane applications.



### **Type III Hose**

CGA Type III hose assemblies and tested / tagged prior to receiving. Type III hose is approved for Liquid Propane and Natural gas vapor and meets the requirements of CAN / CGA 8.1-M86.

- Inner Tube - Thermoplastic.
- Reinforcement - Stainless Steel braid over a textile braid.
- Cover - Oil Resistant Perforated Synthetic Rubber.
- Rated for 350 PSI at temperatures from -40° to 200° F.
- Hydraulically crimped non-reusable hose ends.
- Hydrostatically tested at 1.5 times the working pressure and CGA tagged with the test date.
- 

Fitted for Liquid propane applications.

## Spy® Holiday Detectors



**Spy® Detectors offer accurate, reliable inspection of pipe coating.**

- Technology that combines the case, probe and electrode configuration with new generation solid-state circuitry
- Simplified and more efficient

### Spy® Model 790

For a wide range of coatings the easy-carry and easy to handle SPY Model 790 speeds inspection time with its built in Jeep meter and various other time saving and comfort features.

(5 to 35 kv)



### Spy® Model 785

For thicker coatings such as coal tars, extruded and tape coatings, the Model 785 has a range of infinite voltage settings from 1,000 to 15,000 volts. This wide range permits you to maintain a steady inspection rate on most types of coatings on most pipe sizes without changing detectors. Pulse voltage output only.

(1 to 15 kv) - YJ



### Spy® Model 780

For thin film coatings the easy-carry and easy to handle SPY Model 780 speeds inspection time with its built in Jeep meter and various other time saving and comfort features.

(1 to 5 kv) - Epoxy



## Spy® Model 670 Wet Sponge Detector



For coatings from 1 mil up to 10 mils thick, ordinary tap water can be used to wet the sponge. Above 10 mils, for coatings of 11 to 20 mils thickness, a non-sudsing wetting agent (such as Kodak Photo-flow R®) is recommended to increase the ability of the moisture to swiftly make its way through pin-holes in the thicker coating.



## SPY® Jeepmeter

Check your detectors voltage output with different voltage Jeepmeters.

## SPY® Model JM

The Model JM Jeepmeter provides the ultimate in accuracy and versatility. It features a digital display of measured voltages. The precision measurement displayed eliminates interpretation errors and is perfect for every day tests.

This Jeepmeter measures both pulse and DC voltage output. For pulse type holiday detectors, used to inspect shrink sleeves, tapes, coal tars, etc., the JM will measure up to 40 kv. For DC holiday detectors, used to inspect thin film epoxy coatings, the DC range of the JM measures up to 5 kv.

The JM is powered by two standard 9-volt alkaline batteries.



## SPY® Model PJM

This Pocket Jeepmeter is for high voltage pulse output detectors. It has a range of 0-20 kv. Two standard 9-volt alkaline batteries power the PJM



## SPY® Model DCPJM

The DC Pocket Jeepmeter measures the output voltage of DC holiday detectors. It has a range of 0-5 kv. this DCPJM requires no batteries.



## SPY® Pig Tracker and Sensor



Pig Trackers are devices that are used to track the passage and pinpoint locate a pipeline pig that is equipped with an appropriate transmitter. These devices enable operating and maintenance companies to minimize the costs involved with excavating and removing stuck pigs.

Four different sizes of transmitters are available for use in small and large pipelines. These transmitters vary in battery life as well as power of their output signal.

- Model 1 System is designed for 2-4" pipe using the PT101 transmitter
- Model 2 System is designed for 2-8" pipe using the PT107 transmitter
- Model 4 System is designed for 6" & larger pipe using the PT275 transmitter
- Model 12 System is designed for 12" & larger pipe using the PT750 transmitter

Portable wand based systems are utilized to walk a pipeline to precisely locate a stuck pig. These systems allow for visual and audible indication of pig location.

Pig tracking sensors are utilized to indicate the passage of a pig past a given point in the line. This system can be linked to a SCADA package or simply used to provide an easy to see visual indication.

The Spy Pig Tracker is an electronic pig locating system that will locate your pigs wherever they go - through gathering lines, mainline transmission lines, municipal gas, water and waste water lines, refinery and other industrial piping.

Using strong low frequency signals the Pig Tracker system gives you a more reliable signal life. Depending on the model, the Pig Trackers signal can be received for up to 500 hours. It operates on standard batteries - readily available from retail stores. No recharger is necessary.

The Pig Tracker system consists of a cylindrical transmitter which travels with the pig, and a hand-held pick up wand and receiver that receive the signals and inform the operator of the transmitter / pigs location.



## H&M Saddle Type Beveler



Each machine is constructed of lightweight, hard-anodized aluminum, assuring durability and easy transportation to every job site. Anywhere you go you will be able to cut and bevel 2" to 36" pipe accurately, swiftly and economically, even under the toughest conditions

Model No.	Standard Pipe Sizes	Net Weight	Manual	Motorized	Cuboid Spacers
No. 0	2", 2.5", 3" and 4"	7.50 lbs. (3.37 kgs.)	Std.	Optional	Std.
No. 1	3", 4", 6" and 8"	16 lbs. (7.20 kgs.)	Std.	Optional	Std.
No. 2	7", 8", 10" and 12"	23 lbs. (10.35 kgs.)	Std.	Optional	Std.
No. 3	14", 16", 18" and 20"	51 lbs. (22.95 kgs.)	Std.	Optional	Std.
No. 4	20", 22", 24" and 26"	81 lbs. (36.45 kgs.)	Std.	Optional	Std.
No. 30	24", 26", 28" and 30"	92 lbs. (41.40 kgs.)	Std.	Optional	Std.
No. 5	30", 32", 34" and 36"	145 lbs. (65.25 kgs.)	Std.	Optional	Std.



\* Proline provides in-house service on H&M bevellers as well as Mathey, Sawyer, and Victor products

\* Shape cutting and out of round attachments are also available by special order



## Compact Bevelers

- 10 machines cut pipe ranging from 3" to 60"
- Saddle style machine with full travel ring allows more accurate cuts
- Split frame design allows the machines to be installed over the end of the pipe or over the top of the pipe
- Fully enclosed gear box prevents damage to critical gears
- Precision cast for more rugged strength
- Steel and cast aluminum construction



## Quick Set Bevelers

- 4 machines cut pipe ranging from 1-1/2" to 20"
- Saddle Style Machine with full travel ring allows more accurate cuts
- Split frame design allows the machines to be installed over the end of the pipe or over the top of the pipe
- Unique sliding adjustment arms require no spacers
- Sized for cutting pipe and tubing
- #3 machine comes standard with an out of round attachment
- Fully enclosed gear box prevents damage to critical gears
- Precision cast for more rugged strength



## Sawyer Beveling Bands



- For pipe 6" (152.4mm) and larger
- Bands are made from durable stainless steel for long life
- Adaptable to any beveling requirement
- Smoothly, accurately cuts and bevels
- Flexible 9' (2.7m) drive shaft, standard; 14' (4.3m) optional
- Motorized drive optional
- Minimum clearance needed in bell holes
- Out-of-round pipe attachments unnecessary
- Precision cast for more rugged strength
- Mounts easily anywhere on the pipe
- Above 60" (1524mm) – special order



## Manual Crawlers



- Flexible 9' (2.7m) drive shaft, standard; 14' (4.3m) optional
- Motorized drive optional
- Minimum clearance needed in bell holes
- Out-of-round pipe attachments unnecessary
- Precision cast for more rugged strength
- Mounts easily anywhere on the pipe



## Motorized Crawlers



- Fits all Compact, Quick-set and Band-type beveling transmissions
- Industrial grade fully-enclosed gear motor for durability and long life
- Increased speed control range allows flame or plasma cutting
- Extension cords and plugs are water resistant per IP 67 and are arctic and flame resistant
- Cast aluminum motor mount increases durability and rigidity
- High visibility yellow polyamide control box with integrated handle
- Shielded magnet included on the control box for attachment to pipe during use



## Proline Crawler Motorization Kit



With intelligent firmware and robust safety features, the Proline Crawler Motorization Kit enhances the efficiency and reliability of your pipe cutting system. Built for professionals who demand control and consistency in every cut. Engineered for precision speed management in pipe cutting applications, ideal for the oil and gas industry. This powerful controller delivers consistent, uniform cuts that reduce prep time and streamline your workflow, saving both time and money on the job site.

- **Wide Input Range:** Operates on 35–240 VAC or 35–340 VDC
- **Automatic Speed Control:** Compensates for load and voltage variations
- **Real-Time Diagnostics:** Alerts for overloads, short circuits, overheating, and fuse failure
- **Digital Display:** Shows speed, warnings, and detailed run-time metrics
- **Smooth Operation:** Fast directional switching and four adjustable speed curves
- **Enhanced Safety:** Built-in protections and visual fault indicators
- **Precision Tuning:** Lockable speed settings and deviation monitoring
- **External Fuse:** Convenient fuse replacement and added protection beyond internal fuses



## Sawyer Cordless Motorized Crawler

Sawyer's new cordless motorized crawler is the new industry standard, it is the best of both worlds because it can run on AC or battery power

Features:

- Industrial grade, brushless motor for durability and long life
- Battery-powered, using a DeWalt style 20v battery (not included)
- Intelligent speed control with a range that allows for flame or plasma cutting
- Extension cords and plugs are water, arctic, and flame resistant
- Durable cast aluminum motor mount increases rigidity
- High visibility yellow polymide control box with integrated convenient carrying handle
- Shielded magnet included on the control box for attachment to pipe during use



### NEW EQUIPMENT **Cordless Motor Kit**

New brushless motor drive  
powered by a 20 volt DeWalt style  
battery or AC Adapter



## Radiograph Cutters



The versatile VCM-200 is a precision, tractor-type machine that can be used on its own track for straight line cutting and a variety of welding operations. Off track and with a radius rod assembly, the VCM 200 can be used for circle cutting.



## Victor® Machine Cutting Torches & Tips



Two hose model cutting torches are a "straight through" high performance design that minimizes turbulence and improves cut quality.

### Victor Long Barrel Torch: MT-210A

- Victor MT 204A Machine Cutting Torch, 7 inch Cut Capacity, 14" Length, 2-Hose Manifold Block, Acetylene

### Victor Short Barrel Torch: MT-204A

- Victor MT 204A Machine Cutting Torch, 7 inch Cut Capacity, 8.5" Length, 2-Hose Manifold Block, Acetylene



## Victor® Regulators

- Stem-type seat mechanism that closes with the impact of inlet pressure. Dense, die-forged bodies and spring housing caps provide maximum strength and safety
- Large range of pressure regulators and reverse flow check valves
- Combined regulator/flowmeter combination units and gas manifolds also available



## Cutting Tips

Proline offers a variety of Victor® and other brand cutting tips



**Reed Cold Pipe Cutters**



**Reed Hinged Cutters**

The Reed™ Hinged Cutter is the only hinged cutter recommended for ductile iron. It consists of a four-wheel cutter that cuts steel, cast iron and ductile iron pipe (1" thru 12" pipe diameter). Wheels are available for cast and ductile iron or extra thick wall steel pipe. PROLINE representatives will assist you in selecting the proper wheel depending on the size cutter and material to be cut.



Reed™ Hinged Cutter Sizes	
H4	2 1/2" - 4" Pipe
H6	4" - 6" Pipe
H8	6" - 8" Pipe
H12	10" - 12" Pipe
* for larger cutters please see Reed™ Rotary Cutters	

**Features:**

- 90° to 110° handle swing
- 4" clearance around pipe
- Tough guide fingers ensure perfect alignment for square cuts
- A closed 360° frame allows efficient cutting
- No sparks

**Reed Rotary Cutters / Low Clearance Rotary Cutters (LCRC)**

Reed™ Rotary Pipe Cutter Sizes	
RC20	20" - 22"
RC24	24" - 26"
*Larger sizes may be available by special order	
Reed™ LOW CLEARANCE Rotary Pipe Cutter Sizes	
LCRC8S	5" - 8"
LCRC12S	10 - 14"
LCRC16S	16" - 18"

The Reed™ Rotary Cutter is the best manual cutter for ductile iron and is recommended for large diameter cast iron and steel pipe 5" to 34" pipe diameter (127 mm to 863.6 mm). All sizes use the same cutter wheels. Special wheels are available for ductile and cast iron. PROLINE representatives will assist you in selecting the proper wheel depending on the size cutter and material to be cut.



- Great for cold cuts, fast setup and cutting in close quarters
- New low profile design requires only 4" clearance for up to 16" pipe diameter
- Needs 6"- 8" (152.4mm to 203.2mm) clearance around pipe and 45° to 60° handle swing
- Heavy frame – no Reed rotary cutter has ever broken
- Steel wheels will cut up to 25"-32" wall thickness

## Welding Tents

### Model “W” Welding Tent

- Durable design to withstand rigorous use on pipeline and construction sites.
- Collapses for easy transportation and storage.
- Easily assembled by two people.
- Rugged design for long life and durability
- Readily transported by a crane, fully assembled by hooks that are placed on both ends of the top of the tent.
- Vents in front and back peaks allow air circulation and welding fumes to escape for a safer work environment.

Frame is made from 1” square steel tubing, sandblasted and powder coated (12’ x 12’ frame is fabricated with 1 1/4”). 13/14 oz. high tear flame resistant (FR) PVC cover.

Common sizes are 11’x8’ and 8’x8’

Other sizes available are 12’x12’, 12’x10’, and 10’x10’



### Model “M” Welding Tent

- Ultra-light and economical design.
- Easy assembly by one person.
- Protects from harsh weather conditions.
- Compact enough to fit into the back of a pickup truck, van and even A car.
- Walls on the ends open up for ventilation of hazardous welding fumes.
- Tent frames are constructed from galvanized steel and are rust resistant.
- Frame comes standard with feet installed in the end poles for more stability.
- Can be used for multiple industries and applications.
- Custom branding available.



6 oz. flame resistant (FR) fabric cover.

Passed FR Testing to CAN/ULC – S109 and CPAI-84 Section 6 Standards.

**Sizes: 6’ x 7’ and 7’ x 8’ with 6’ walls, 8’1” peak.**

Reinforced orange strip on doors and corners for high visibility safety identification.

### 10' X 10' ES100S Instant Shelter/Pop-Up Tent

- Dura-Lon® Sidewalls: High-quality materials deliver long-lasting weather resistance and privacy.
- Portable and Convenient: Includes a roller bag for effortless transport and storage.
- Easy Setup: Comes with a 4-piece spike kit to secure the tent in various outdoor settings.
- Meets CPAI-84, NFPA-701, and CAN/ULC-S109 Fire Resistant Requirements.
- Adjustable legs with 3 height settings.
- Light Weight: Less than 60 lbs.



Its classic design provides 100 square feet of sheltered area, protecting you from the sun, rain, and wind while giving you ample space to work.

Shipping Weight: 68 lbs. (30.7 kg)

Maximum Peak Height: 11' 5" (3.5 m)

Maximum Headroom: 6' 10" (2.0 m)

Maximum Valance Clearance Height: 6' 10" (2.0 m)

## Welding Blankets

Prevents weld cracks by keeping welded pipes from cooling to quickly.

- Glass cloth on underside and canvas on top with 1" Fiberglass insulation
- Blankets are secured by a 1" flat elastic strap with S-hook that fastens
- to a cotton webbing loop providing a tight fit to pipes
- Available in 9" & 12" widths with varying lengths



Standard Multi-size blankets:		
Pipe Size	Width	Length
3" to 6"	9"	28"
8" to 12"	9"	50"

## Welding Umbrellas

- This umbrella has a 6-rib construction with an approximate spread of 64".
- This 2-piece handle is 1 1/4" diameter tubular steel and contains a flat bottom pole.
- The total height is 66" from top to bottom.



## Cat Tarp

Keep your equipment operating in severe winter weather.

- Manufactured with 14.7 oz. treated canvas.
- Available in 2 widths on 100 ft. rolls - simply cut to desired length.
- Brass grommets installed every 2' along both sides enabling attachment to all models of equipment.

**Available Sizes:**

Width x Length
36" x 100
44" x 100



## Spacing Tools & Wedges

### Zinc Spacing Tool

Large Tool - Dimensions: 1 1/2" Wide, 8" Long, 1/4" Thick  
Small Tool - Dimensions: 3/4" Wide, 8" Long, 1/4" Thick



**Coloured Spacing Tool (G.O. Spacing Tool)**

Colours: Gold, Silver, Black, White, Red, Orange, Yellow, Green, Light Blue, Dark Blue

Large Tool - Dimensions: 1 1/2" Wide, 8" Long, 3/8" Thick

Small Tool - Dimensions: 1" Wide, 8" Long, 1/4" Thick

Spacing Tool Material: Tempered, High Carbon Spring Steel\*  
\*Spring steel has a very high yield strength. This allows objects made of spring steel to return to their original shape despite significant bending or twist.

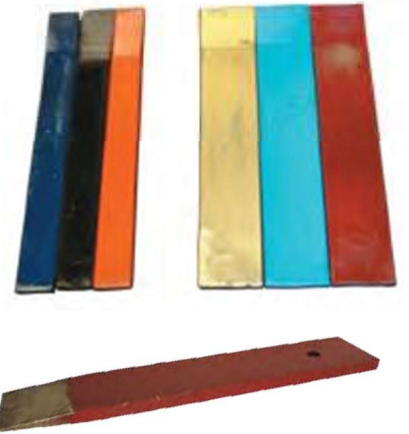

**Red Spacing Tool**

Pipe fitters spacing tool, made from case hardened, tempered steel. Pre-drilled to allow for tie-off where required.

Dimensions: Width: 1 1/2" Length: 8" Thickness: 3/8"

**Wedges**

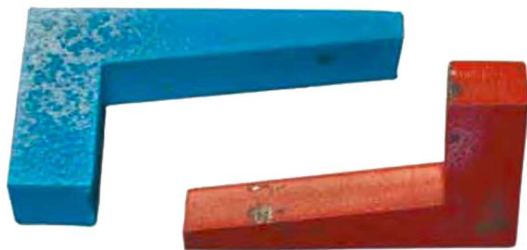

**Hi/Low Wedge**

Length: 6"  
Height: 3-1/2"  
Width: 1"



**6lb. Fallers Wedge**

Weight: 6lb.  
Length: 10"  
Width: 2"

## Show Dawgs

Show Dawgs securely hook and lock into external line up clamps and various cage clamps ranging from 16" - 84" and are the safest most accurate way to facilitate HI - LO issues.

Show Dawgs remove the need of using hammers or pins which could potentially cause damage to the pipe.

- Made from high impact 4140 heat treated steel.
- Handles up to 170-foot pounds of torque.
- Threads come with silver anti seize rated up to 1600F.
- Works with 16" - 84" external clamps/cage clamps.



## Magnetic Ground Clamp

- Brass bushings to ensure good contact
- Avoid costly grounding arc
- Flips out of the way



## Magnetic Grinder Holder

Saves you time and money by keeping the grinders at your fingertips while making sure tools are out of the dirt.

- Improve grinder safety
- Saves wear and tear on tools
- Save time by keeping the tools at your finger tips
- Designed with pipe liners needs in mind
- Engineer certified



## Chain Clamps

### Single Jackscrew Chain Clamp

The Single Jackscrew Chain Clamp reforms the mating side of the weld gap only, and is capable of reforming up to Schedule 40 pipe. The jackscrews of the jackbar exert pressure on the high points of the mating pipe eliminating "Hi-Lo" as pipe and fittings are aligned. Pipe wall thickness to Schedule 80 can be aligned with the Single Jackscrew Chain Clamp.

The level and support device of the chain clamp allows the pipe, elbow, tee, flange and other fittings to be held safely and securely in place during the alignment and welding process. For stainless steel or specialty alloy applications, replace the chain of the standard chain clamp with stainless steel chain.



### Double Jackscrew Chain Clamp



The Double Jackscrew Chain Clamp reforms Schedule 40 pipe on either side of the joint to be welded. The jackscrews of the jackbar exert pressure on the high points of both sides of the weld joint to eliminate "Hi-Lo". Pipe wall thickness up to Schedule 80 can be aligned with the clamp.

The level and support device of the chain clamp allows the pipe, elbow, tee, flange and other fittings to be held safely and securely in place during the alignment and welding process.

For stainless steel or specialty alloy applications replace the chain of the standard chain clamp with stainless steel chain.



Available in steel and stainless steel models to fit pipe from 1" to 54" (25mm to 1372mm).

### Deerman Light Chain Clamp

The ideal chain clamp for the welder or fitter who does not need to reform elbows, tees or other fittings. The Dearman Light series of Chain Clamps are durable and versatile and, like the original Dearman Chain Clamp, reform up to Schedule 20 and align up to Schedule 40 pipe. The jackscrews in the jackbar give the welder the ability to obtain the optimum fit-up of the pipes or fittings to be joined.



This light-weight clamp is rapidly adjusted to any pipe diameter by pulling the chain through the main block. Precision outside or inside diameter alignment can be quickly obtained without operator fatigue.

### Universal Chain Clamp

The Universal Chain Clamp's design gives the welder the ability to accurately fit-up, weld and grind the pipe without removal of the clamp. The level and support device of the chain clamp allows the pipe, elbow, tee, flange and other fittings to be held safely and securely in place during the alignment and welding process.

Replace the chain of the Universal Chain Clamp with stainless steel chain for stainless steel or specialty alloy applications. Available in carbon steel and stainless steel models to fit pipe from 1" to 36" (25mm to 914mm).



### Double Chain Clamp

The Double Chain Clamp is a heavy-duty vessel clamp designed for alignment and reforming of pipes and vessels up to 20' (6M) with Schedule 80 wall thickness. Aligns Schedule 80 pipe and over when no reforming is required.

The extra heavy-duty jackbar and main block provide the brute strength to accomplish difficult reforming jobs. Models 10" to 36" thru 10" to 54" come with level and support device and all other models come with cable hoist. The Double Chain Clamp is available in steel and stainless steel models and is shipped in a wooden storage crate.



### Hydraulic Chain Clamp

The Hydraulic Double Chain Clamp has a power hydraulic tensioning mechanism incorporated into its design. The hydraulic cylinder of the hydraulic tensioning mechanism, which has a 5" (127mm) stroke, applies up to 10,000 lbs (4535kg) of tension to the standard Double Chain Clamp. Rapid and effortless tensioning can be applied to the Double Chain Clamp to close it on the pipe.

Hydraulic pressure is supplied to the cylinder by a hand pump with reservoir. The clamp is specifically designed to align pipe up to Schedule 120 and reform pipe to Schedule 80.



## Ratchet Clamps



### KC Ratchet Clamps

- Screw type clamp with reversible ratchet
- Machined pads to fully contact O.D. of pipe
- Constructed of rolled, heavy rectangular bar stock for maximum strength when clamping out-of-round pipe
- High clamping, even pressure for maximum alignment

Ratchet style available for pipe 8" - 60"



## Lever Clamps



### KC Toggle Clamps

- A cast and machined high strength clamp
- High clamping pressure created by the toggle latching mechanism
- Low profile with large window access to the pipe
- Available for 3"-8" pipe



### Tipton Lever clamps

- Tightens with hand lever
- Simple, quick, easy to use
- Available in sizes up to 60"(1524mm) pipe diameter

#### Optional:

- Hydraulic mechanism exerts extra pressure for aligning large pipe
- No Tack Crossbars are arched to permit a full circle weld to be completed without removal of the clamp.



## Fast Fitting Clamps

The Quik-Fit Clamp offers the most advanced method of achieving quick, easy and precise fit-ups. The Quik-Fit is a tack-type clamp that requires no special training to use.

Quik-Fit is available in 3 sizes to cover a range of 1" to 12" pipes, and can be used on both carbon and stainless steel without adding special shoes or screws. The clamp will not only align pipe to pipe, pipe to fitting, pipe to tee, or pipe to flange, but can also be used to adjust for pipe "Hi-Lo".

The light weight and simple design makes the Quik-Fit Clamp ideal for applications where "out-of-round" conditions do not exist.



- Umbrellas
- Sand Bags
- Pipe Hooks
- Torches
- Buffing Wheels
- Grinding Discs
- Welding Jackets
- Welding Sleeves
- Flint Guns
- Files
- Brass Hammers
- Gloves
- Temp Sticks
- Lumber Crayons
- J-Rollers
- Lifting Slings
- Cooling Blankets
- Ground Clamps
- Knee Pads
- Engineer Handbooks
- Eye Levels
- Skid Hooks
- Spacing Tools
- Fallers Wedges
- Primer Brushes
- Lino Knives
- Bending Protractors
- Sweep Magnets
- Nite Caps
- Welding Tents
- Safety Glasses



## ATKINS 35100-K Thermocouple

The AquaTuff™ 35100-K model is a high accuracy instrument designed to withstand harsh environments. The ABS housing is extremely durable and IPX7 waterproof rated. The housing is ergonomic with a tapered design and curved back to fit nicely in your hand. The 35100-K can be used with any Type K thermocouple probe with a standard mini-connector. Cooper-Atkins offers a wide selection of probes for use in industrial and foodservice applications. Manufactured in an ISO 9001:2008 facility in the USA.



### Specifications:

Certification	CE, NSF Component, RoHS, WEEE, NIST
Warranty	5 Year Instrument Warranty
Auto Off	Yes, after 10 minutes of non-use
F/C Switchable	Yes
Features	Easy twist-open battery hatch
Temperature Range	-100° to 999°F (-73° to 537°C)
Temperature Accuracy	±0.5F° (±0.3C°) over entire measurement range at ambient temperatures from 68°F to 86°F (20°C to 30°C)
Ambient Temperature Range	32° to 122°F (0° to 50°C)
Resolution	0.1°
LCD Height	.5" (12.7mm)
Waterproof Rating	IPX7 Waterproof Rated
Housing Material	ABS
Battery Type	(2) AAA
Battery Life	1800 hours
Weight	0.3 lb (136 g) including batteries
Dimensions	6.5" x 1.25" x 2.25" (165 mm x 31.8 mm x 57.1 mm)

## Cooper Atkins 50012-K Angled Bell Surface Probe with Coiled Cable.

This angled bell surface probe with type K plug is designed for use on any flat surface. It features a swiveling bell sensor that self-orients to the surface for maximum contact and a polyurethane-coated coiled cable that is 12 when retracted and 48 when extended.

This probe has a temperature range of -40 degrees to 500 degrees F  
Max Cable Temperature: 176 degrees F



## Positector Wall Thickness Gauge

This Defelsko ultrasonic wall thickness gage measure the thickness of materials such as steel, plastic and more using ultrasonic technology. Ideal for measuring the effects of corrosion or erosion on tanks, pipes or any structure where access is limited to one side. The standard model measures the wall thickness of materials such as steel, plastic and more. Ideal for measuring the effects of corrosion or erosion on tanks, pipes or any structure where access is limited to one side.

### Features:

- 5 MHz dual element transducer
- Scan Mode - measurement rate of 20 readings per second with on-screen min and max for quick inspection over a large area
- Comes complete with probe, couplant, protective rubber holster with belt clip, 3 AAA batteries, instructions, nylon carrying case with shoulder strap, Certificate of Calibration traceable to NIST

### Simple:

- Large, easy-to-read, graphics LCD with multilingual support
- One-handed menu navigation
- Pre-programmed velocities - simply select from a list of common materials or enter your own with ease
- Bi-color indicator light - ideal in a noisy environment
- RESET feature instantly restores gage to factory settings

### Accurate:

- Precision ultrasonic transducers provide fast, accurate readings
- Certificate of Calibration showing traceability to NIST
- Hi-RES mode increases displayed resolution for use on applications that require greater precision to NIST included with every gauge
- Conforms to national and international standards including ASTM E797



## Positest FM Thickness Gauge

Magnetic pull-off thickness gage for the Non-destructive measurement of non-magnetic coatings (paint, enamel, plastic, galvanizing, metalizing, plating, etc.) on STEEL.

### Accuracy

- Highly wear resistant Carbide Probe for longest life and continuous accuracy
- Modern and up-to-date gauge Scale Ranges fit all applications
- Conforms to national and international standards including ISO and ASTM.



### Durability

- Extra rugged gauge housing, not affected by mechanical shock, water, acid or solvents
- Unique overall gage design, fully supported, positive positioning, no pivoting tendencies during measurement
- Gage can be used fully supported or with only the front probe area contacting the surface
- Functions on a permanent rare-earth cobalt magnet, no battery
- Explosion Proof - Refinery safe
- Positive visual and audible indicators to designate when thickness reading is established
- "V" grooves in probe housing and Gauge base allow correct positioning on cylindrical objects
- Compact, lightweight, precisely balanced, Independent of gravity - Gauge can be used in any position
- GO / NO-GO button can be pre-set for rapid measurement
- Probe contact and dial rotation all in a one-finger operation
- Gauge is furnished with wrist strap, neck strap and instructions in a high quality leather case with belt loops for your convenience

## Testex Spring Micrometer

The Testex Gauge is a precision, spring-loaded Dial Thickness Gauge specifically designed for measuring thickness of Testex replica tape. Range of .0001" to .050"; resolution of .1 mil The Testex Micrometer is stocked in imperial units. A metric version is available by special order.



## Testex Tape

Testex Press-O-Film replica tape is available in a variety of thicknesses to facilitate profile measurement in differing ranges.

The primary range for measurement with replica tape is 0.8 to 4.5 mils (20 to 115 um). Use of Coarse Minus grade (<0.8 mil or <20 um) or X-Coarse Plus grade (>4.5 mil or >115 um) should be restricted primarily to checking measurements at the lower and upper ends of the primary range.



Grade (descriptive)	Range When Used With Gage (mils) / (um)
Fine / Medium	not applicable
Coarse Minus	0.5 to 1.0 / 12 to 25
Coarse	0.8 to 2.5 / 20 to 64
X-Coarse	1.5 to 4.5 / 38 to 115
X-Coarse Plus	4.6 to 5.0 / 116 to 127

## Wet Film Thickness Gauge

Disposable W.F.T. Gauge  
Aluminum Size: 2.25" x 3.25"  
Range: 1 to 80 mils.  
Flip Side: 25 to 2032 microns

MEETS ASTM DESIGNATION

Place gauge on wet film at 90° angle  
Press into film

Withdraw and note deepest tooth having paint on it and next higher tooth that is not coated  
The wet film thickness lies between these two readings  
Clean gauge in any suitable solvent immediately after use

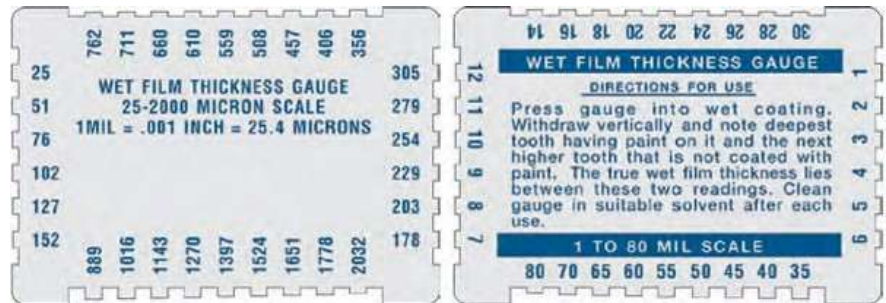

The drawing indicates that tooth marked 3 mils is covered with the wet paint and tooth marked 4 mils is not covered. This indicates that the true wet film thickness of the material is between 3 and 4 mils thick.

## Firm Joint Calipers

### Outside Firm Joint Calipers

Starrett Firm Joint Calipers feature an improved joint which has been designed so tension is adjustable to meet the various user requirements. Once adjusted, the tension remains the same with the opening and closing of the legs. The legs are made of a high-grade steel and the capacity of these calipers is generally 1/3 greater than the length of the particular caliper legs.

- 26-6 Starrett Outside-Type Calipers - 6" Leg Size
- 26-12 Starrett Outside-Type Calipers - 12" Leg Size
- 26-18 Starrett Outside-Type Calipers - 18" Leg Size
- 26-24 Starrett Outside-Type Calipers - 24" Leg Size
- 26-36 Starrett Outside-Type Calipers - 36" Leg Size



### Inside Firm Joint Calipers

Firm-joint outside caliper has an improved joint, designed so the tension can be adjusted as desired. After adjustment has been made, the tension will not change with the opening and closing of the legs.

- Joint design allows for tension adjustment
- Tension does not change with leg movement
- Legs made from high-grade steel for ruggedness
- Caliper opens to approximately 1/3 greater than leg size
- Curved tips transfer the measurement of the internal size of an object

- 27-6 Starrett Inside-Type Calipers - 6" Leg Size
- 27-18 Starrett Inside-Type Calipers - 18" Leg Size
- 27-24 Starrett Inside-Type Calipers - 24" Leg Size



## G.A.L. Pit Gauge

Range is 0 to 1/2" in 1/64" & .020 increments  
 Arm can be locked in place at any dimension  
 All stainless steel construction  
 Gauge will fit in shirt pocket & comes in a pocket protector  
 Has handy formulas on front & decimal equivalents on back

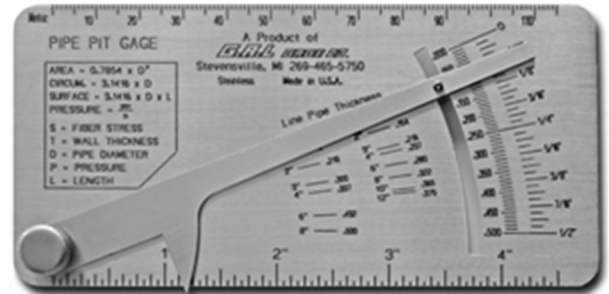

## Tri Gauge

The Tri-Gauge® is today's most versatile Lever Pit Gauge, with its Metric and dual Imperial Scales. Additionally, the Tri-Gauge® serves as a basic Weld Inspection Gauge for; Undercut Depth, Weld Crown Height, a Porosity (diameter) Comparator; and both Metric and Imperial Rules. The Tri-Gauge® is fitted with a Patented pointer Offset Correction® for improved accuracy and repeatability. Lever Pit Gauges are intended to evaluate corrosion, and not as an absolute measuring tool. The Tri-Gauge® is supplied with a Pocket Protector type Case and Instructions



## Hi-Lo Gauge

HI-LO Welding Gauge measures internal alignment  
 Measures internal alignment of pipe after fit-up/alignment, cuts radiographic rejects  
 Measures internal misalignment of pipe before and after tracking  
 Measurements read in standard on one side and metric on the opposite side  
 Stainless steel construction  
 Satisfy fit-up codes, ASME, ANSI, API & Military



## Gauss Meters

We offer 3 Models of the W-FI Field Indicators. Field Indicators (Magnetometers) are designed to aid MPI Inspectors to:

- Check for Magnetism before testing
- Check the Polarity of a Field.
- Check Magnetism after Demagnetizing
- Check the Direction of the Field



While simply mentioned in ASTM and ASME Specifications, Field Indicators are outlined in the ASNT Handbook Nondestructive Testing Handbook, Second Edition: Volume 6, Magnetic Particle Testing (2nd Edition). These mechanical Field Indicators are an economical alternative to Hall Effect Gauss Meters

## Pipe Wrap

Mathey Dearman Pipe Wrap has double-ruled edge so it is never upside down or backwards. The Wrap can be used as a straight edge to mark straight lines around the pipe and to mark angles for pipe elbows. The Pipe Wrap is constructed of highly abrasion and solvent resistant materials to last under heavy use.

Pipe Wrap Includes:

- Table of tangents and straight edge
- Instructions for cutting elbows
- Sides marked in 1/8" (3.2 mm) increments to 36" (914 mm)
- Instructions for finding the length of an elbow
- 45-degree angle chart
- Degree markings



Model	Description	Pipe Size in (mm)	Size
D160	Wrap, 4" x 4' / 102 mm x 1219 mm	3-15 (76-381)	Medium
D170	Wrap, 4" x 6' / 102 mm x 1829 mm	3-22 (76-559)	Large
D177	Wrap, 4" x 7' / 102 mm x 2134 mm	3-26 (76-660)	Extra Large
D184	4" / 102 mm Width x Length Desired Sold in 1' / 305 mm Increments	Pipe size to be specified	
D185	5" / 127 mm Width x Length Desired Sold in 1' / 305 mm Increments	Pipe size to be specified	
D187	7" / 178mm Width x Length Desired Sold in 1' / 305mm Increments	Pipe size to be specified	

## Foam Pigs

### Bullet Nose Pigs

RBS-BN (Red Bare Squeegee Bullet Nose)

- Regular Wiping and Dewatering of Pipelines
- Line Proving
- Gauging Pig to Determine Pipe I.D.
- Removal of Thick, Soft, Internal Deposits
- Condensate and Liquid Removal from Wet
- Gas Systems
- Product Removal
- Pigging Multi-Diameter Pipelines
- Used as a Sealing Pig
- Available in Double Dish (RBS-DD) design for bi-directional Operation
- Handling Ropes or Steel Cables (Optional)
- Transmitter Cavities for Use with Pig Locators (Optional)
- Regular Wiping
- RSS (Red Single Spiral)



### Double Dish Pigs

RBS-DD (Red Bare Squeegee Double Dish)

- Designed for Bidirectional Operation
- Regular Wiping and Dewatering of Pipelines
- Line Proving
- Gauging Pig to Determine Pipe I.D.
- Removal of Thick, Soft, Internal Deposits
- Condensate and Liquid Removal from Wet
- Gas Systems
- Product Removal
- Pigging Multi-Diameter Pipelines
- Used as a Sealing Pig
- Handling Ropes or Steel Cables (Optional)
- Transmitter Cavities for Use with Pig Locators (Optional)
- RSS (Red Single Spiral)
- Regular Wiping



### Soft Foam Pigs

YBS (Yellow Bare Swab)

- Drying and Wiping of Pipelines
- Line Proving
- Pigging Multi-Diameter Pipelines
- Used as a Sealing Pig
- Available in Cylinder Shape (YBS) or Bullet Shape (YBS-B)
- Handling Ropes or Steel Cables (Optional)
- Transmitter Cavities for Use with Pig Locators (Optional)



### Criss Cross Pigs

RBS-DD (Red Bare Squeegee Double Dish)

- Designed for Bidirectional Operation
- Regular Wiping and Dewatering of Pipelines
- Line Proving
- Gauging Pig to Determine Pipe I.D.
- Removal of Thick, Soft, Internal Deposits
- Condensate and Liquid Removal from Wet Gas Systems
- Product Removal
- Pigging Multi-Diameter Pipelines
- Used as a Sealing Pig
- Handling Ropes or Steel Cables (Optional)
- Transmitter Cavities for Use with Pig Locators (Optional)
- RSS (Red Single Spiral)
- Regular Wiping



### Wire Brush Pigs

RCC-WB (Red Criss-Cross Wire Brush)

- Regular scraping of pipelines
- Recommended for most tuberculated pipelines
- Removal of construction debris or other foreign materials after new construction
- Used to remove hard scale, paraffins, and heavy materials
- Available in Double Dish (RCC-WB-DD) designed for bi-directional operation
- Handling ropes or steel cables (Optional)
- Transmitter cavities for use with pig locators (Optional)



**Cavity Pigs**

Designed to carry transmitter for Pig Tracking.



**Urethane Pigs**

Proline offers a variety of urethane pigs. Contact Proline for Maxi Disc, Filming, SUD Pigs and more...



## Construction Pigs

### Mandrel Bodies

Proline Manufactured Steel pig bodies.



### Scaper Cups

Our Scaper Cups are designed with a deep squared off edge for better sealing and longer scraping action. Cups are available in all durometers most common is 85 durometer. The arbor hole(s) can be sized and/or patterned for any steel or urethane pig body. Urethane Guide Discs, Spacer Disc and Wiper Discs are also available. Wiper discs are also known as scraper discs or sealing discs. Pig body's (Mandrel Pigs) can be assembled with gauging plates and/or wire brush.



### Gauge Plates

Aluminum gauging plates are used in conjunction with steel pig bodies (sometimes called 'mandrels') to prove pipe roundness and to ensure excessive weld penetration or debris does not exist in the line, as well as, proving minimum bend radius prior to intelligent pig runs. Gauging plate OD's range anywhere from 90% to 95% of the internal diameter of the pipe and can also have slots cut into the circumferential perimeter for easier deformation identification. The standard construction material for gauging plates is 1/4" thick aluminum, but mild steel can also be used.



**I-Series Muniball® Multisize Plugs**



The Muni-Ball® Plug was introduced over 50 years ago and the Cherne brand continues to be the most trusted name in pneumatic plugs today. Muni-Ball® Plugs offer a full bypass allowing both testing and monitoring of piping systems. Muni-Balls® are ideal for installation and repair of residential or commercial piping systems. Cherne Muni-Ball® products can also be used for maintenance of municipal infrastructure, including sanitary and storm sewer pipe systems. Muni-Ball® plugs are durable, rugged and are effective on almost any type of pipe.

Every inflatable plug must pass a severe pressure test and is identified by a serial number. With each Muniball pipe plug, we supply the test certificate and a leaflet describing the features of the sewer plug and providing information on its safe use.



Part Number	Nominal Size	Bypass Diameter (NPT)	Usage Range	Max Back Pressure	Inflation Pressure	Weight (lbs)	Length (in)
311088	4" – 8"	1/2" M	3.95" – 8.25"	15 psi (1 bar)	45 psi (3 bar)	4.7	23
311128	6" – 12"	1" M	5.5" – 12.25"	15 psi (1 bar)	45 psi (3 bar)	9.5	25
212128	8" – 12"	2" M	7" – 12.25"	15 psi (1 bar)	45 psi (3 bar)	12.3	18.5
312168	8" – 16"	2" M	7.5" – 16.25"	15 psi (1 bar)	45 psi (3 bar)	15.9	28
214188	12" – 18"	3" M	10.75" – 18.25"	15 psi (1 bar)	45 psi (3 bar)	28.1	25
613188	12" – 18" with sleeve	3" M	10.75" – 18.25"	15 psi (1 bar)	45 psi (3 bar)	43	25
312248	12" – 24"	3" M	11" – 24.25"	15 psi (1 bar)	45 psi (3 bar)	35.2	37
654248	12" – 24" with sleeve	3" M	11" – 24.25"	15 psi (1 bar)	45 psi (3 bar)	50.2	37
312338	15" – 32"	2" M	15" – 32"	12.2 psi (0.8 bar)	25 psi (1.7 bar)	80	63
612338	15" – 32" with sleeve	2" M	15" – 32"	12.2 psi (0.8 bar)	25 psi (1.7 bar)	108	63
314338	15" – 32"	4" M	15" – 32"	12.2 psi (0.8 bar)	25 psi (1.7 bar)	80	63
614338	15" – 32" with sleeve	4" M	15" – 32"	12.2 psi (0.8 bar)	25 psi (1.7 bar)	108	63
314428	20" – 40"	4" M	20" – 40"	10 psi (0.7 bar)	25 psi (1.7 bar)	120	70
614428	20" – 40" with sleeve	4" M	20" – 40"	10 psi (0.7 bar)	25 psi (1.7 bar)	158	70
316428	20" – 40"	6" M	20" – 40"	10 psi (0.7 bar)	25 psi (1.7 bar)	128	70
616428	20" – 40" with sleeve	6" M	20" – 40"	10 psi (0.7 bar)	25 psi (1.7 bar)	166	70
314448	24" – 48"	4" M	20.5" – 50"	10 psi (0.7 bar)	25 psi (1.7 bar)	125	84.5
614448	24" – 48" with sleeve	4" M	20.5" – 50"	10 psi (0.7 bar)	25 psi (1.7 bar)	178	84.5
316448	24" – 48"	6" M	20.5" – 50"	10 psi (0.7 bar)	25 psi (1.7 bar)	135	84.5
616448	24" – 48" with sleeve	6" M	20.5" – 50"	10 psi (0.7 bar)	25 psi (1.7 bar)	173	84.5
314618	24"-60"	4" M	20.5"-60.5"	6 psi (.41 bar)	25 psi (1.7 bar)	154	101
614618	24"-60" with sleeve	4" M	20.5"-60.5"	6 psi (.41 bar)	25 psi (1.7 bar)	219	101
316618	24"-60"	6" M	20.5"-60.5"	6 psi (.41 bar)	25 psi (1.7 bar)	189	101
616618	24"-60" with sleeve	6" M	20.5"-60.5"	6 psi (.41 bar)	25 psi (1.7 bar)	254	101

## Wing Nut Test Plug

The Series A Wing Nut Test Plugs are designed and developed for testing for leaks and for sealing off sections of pipelines generally made of cast iron, steel, vitrified clay, concrete etc. These plugs come with a hollow stem which can be used as a fill or drain pipe. Turning the wing nut expands the rubber ring tightly against the inside of the pipe. Hand tightening is usually adequate in smaller sizes, but a wrench can be used on larger sizes to give a better seal.

LOW PRESSURE PLUG FOR WATER ONLY

Maximum test pressures are dependent upon the friction of the test plug rubber with the inside of the pipe.

Standard inventory for pipe sizes 1 1/2" - 16" larger sizes may be available by request.



## Cherne® Test Plugs

The Cherne Test-Ball has been the contractor's choice for over 50 years and continues to be the most trusted pneumatic test ball in the industry. Designed for applications from pressure testing and blocking of residential DWV systems to repair maintenance and installation of municipal infrastructure including storm and sanitary sewer piping systems, The Cherne Test-Ball does it all.

Cherne Test-Balls are durable, rugged and effective in any type of pipe.

- Multi-size: More options, less inventory
- Available with patented field repairable rupture disc technology
- 1/4" Schrader tire valve standard on all plugs
- Large plugs feature a removable valve allowing them to be repaired or replaced with quick disconnect fittings
- All Test-Balls are bendable to 90°



Cherne Test-Balls are now available with patented Rupture Disc Technology. This feature prevents over inflation of the pneumatic plug. Rupture Disc Technology also prevents damage to cording. Damaged cording is an unseen condition that compromises plug performance.

## Gas Bags

PROLINE offers a low pressure Inflatable Gas Bag that is designed to inflate to the exact diameter of the pipe to block dangerous fumes or gases from coming forward during repair of an active pipeline.

### Features:

- Varying gauges of rubber and polyester depending on the size
- Ensures a snug fit and good shut-off
- Pressure gauges available
- Optional flame retardant cover and nitrile rubber bladder

Type "C" Bags are for use wherever a plain rubber bag would not hold. This covered bag consists of an inner bag made of a hydrocarbon-resistant nitrile rubber bladder that is then encased in a 100% Polyester fabric cover. The gauge of rubber and polyester vary with the size of the bag. Each size bag is expertly made to insure a snug fit and good shut-off when inflated. Inflating valves are standard with each bag; pressure gauges are recommended and can be furnished at an extra cost. Covers can be made flame retardant at an extra cost.



## Inflatable Multi-Sized Purge Bladders

The I-Purge X is a highly advanced and adaptable modular inflatable bladder system that can fit multiple pipe sizes. It utilizes Bladder Expansion Technology (BET) that allows bladders to expand and contract to fit different piping specifications.

The bladders are protected by a spark-resistant exterior cover that does not combust when exposed to flames or sparks.

The system offers multiple configurations, including a one-sided pipe stopper and reducer. It comes in various sizes and may be purchased as a complete system or individual components. The I-Purge X is a versatile and long-lasting solution that is ideal for fabrication shops and any environment with pipe accessibility.

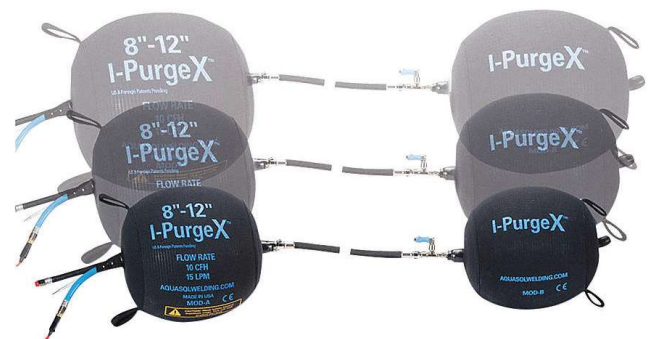

## Mud Plug Kits

A convenient, environmentally friendly assembly of items, used in the field where hot tie-ins are being done. This temporary barrier protects against traces of gas that may exist in pipelines or in gas plants during shut downs. Each kit contains everything you will need to perform the job efficiently and effectively in the field, or in the plant. Once service is complete, the plug can be washed away cleanly and safely.

### Kit Contents:

- MSDS & Instructions
- Pail
- 16 lb of Bentonite
- 2 x 3.78L Jugs washer fluid
- Mask
- Gloves
- Mixing Stick
- Rags



**PROLINE**  
PIPE EQUIPMENT INC.

7141 - 67th ST NW | Edmonton, AB | T6B 3L7  
Ph: 780.465.6161 | Fax: 780-469-3590  
[www.proline-global.com](http://www.proline-global.com)

## MUD PLUG KIT

**Contents:**

- 1 x 16lb Bag of Mud Plug Powder
- 2 x 3.78 Low Temp Washer Fluid (-40 C)
- 1 x Dust Mask
- 1 x Pair Rubber Gloves
- 1 x Stir Stick
- 2 x Rags
- 1 x MSDS Sheet

**Directions:**

1. Empty contents of kit from the pail
2. Put on protective dust mask and gloves
3. Pour entire bag of Mud Plug Powder into the pail and mix with the low temp. washer fluid, mixing consistently with the stir stick
4. Apply mud as needed

**WARNING** Ensure use of protective equipment such as gloves and dust mask as Mud Plug Powder may be harmful if inhaled and corrosive if in contact with skin.

## Link Seals

Link-Seal® Modular Seals are considered to be the premier method for permanently sealing pipes of any size passing through walls, floors and ceilings. In fact, any cylindrical object may be quickly, easily and permanently sealed, as they pass through barriers.

- Saves money and time
- Positive hydrostatic seal
- Long seal life
- Maximum protection against corrosion
- Oil, jet fuel and temperature resistant material available
- Configure a Link-Seal® modular seal to match your application
- ISO quality assurance



Type	Version	Sealing Element	Pressure Plates	Bolts and Nuts	Temp. Range	Application
C	Standard	EPDM-rubber black	Reinforced Nylon Polymer	Carbon steel zinc dichromated	-40° C + 80° C	General application at normal atmosphere, in water or a humid environment. Suitable for electrical insulation and cathodic protection.
B	Shore 40±5	EPDM-rubber blue	Reinforced Nylon Polymer	Carbon steel zinc dichromated	-40° C + 80° C	See under type "C", especially for plastic pipes
S 316	Standard stainless steel	EPDM-rubber black	Reinforced Nylon Polymer	stainless steel	-40° C + 80° C	High resistance against water, most other inorganic substances (acids and alkalis) and against most organic substances (e.g. acetic, acid, acetone).
O	Oil resistant	NITRILE-rubber green	Reinforced Nylon Polymer	Carbon steel zinc dichromated	-40° C + 70° C	Good resistance against oil, aromatic fuels, solvents and other mineral oil base products.
BS	Shore 40±5	EPDM-rubber blue	Reinforced Nylon Polymer	stainless steel	-40° C + 80° C	See type "S 316", especially for plastic pipes
OS	Oil resistant	NITRILE-rubber green	Reinforced Nylon Polymer	stainless steel	-40° C + 70° C	Good resistance against oil, aromatic fuels, solvents and other mineral oil base
KTW	Shore 45±5	EPDM-rubber black incl. KTW-Stamp*	Reinforced Nylon Polymer blue	stainless steel	- 40° C + 80° C	Appropriate for drinking water applications
T**	High and low temperature	SILICONE-rubber grey	St 37 zinc dichromated	Carbon steel zinc dichromated	- 55° C + 230°	No insulating properties, especially suitable for extreme temperatures.

The radial expansion of the rubber ensures the hydrostatic pressure tightness



## End Seals

### Model "C" End Seals

Model "C" Custom Pull-on End Seals are designed to accommodate custom carrier/casing diameter combinations. They are made to customer supplied specifications so they may be used for any size casing/carrier differential. Manufactured from 1/8" thick specially compounded synthetic rubber, PSI Model "C" end seals are extremely robust, resistant to wide variations in environmental conditions while eliminating the possibility of foreign material entering the opening between carrier and casing pipes.



### Model "R" End Seals

Model "R" End Seals are available in five (5) different sizes to accommodate a wide range of carrier/casing diameter combinations. A unique "cone" design, with molded-in dimensions, are easily cut to size for a correct fit on the carrier pipe.

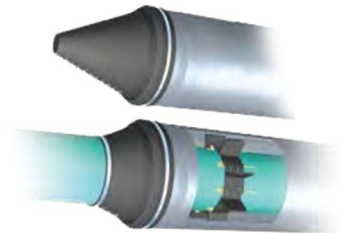

### Model "S" Standard Pull-on End Seals

Model "S" Standard Pull-on End Seals are flexible and easily installed on Nominal Steel & IPS casing/carrier pipe combinations. PSI Model "S" end seals are extremely robust, resistant to wide variations in environmental conditions while eliminating the possibility of foreign material entering the opening between carrier and casing pipes.



### Model "W" Wrap Around End Seals

Model "W" Wrap Around End Seals are designed to accommodate customer supplied specifications so they may be used for any size casing/carrier differential. PSI Model "W" end seals are extremely robust, resistant to wide variations in environmental conditions while eliminating the possibility of foreign material entering the opening between carrier and casing pipes.



### Model "FW" Fire Resistant End Seals

Model "FW" Fire Resistant End Seals have been developed for applications identified as fire prone areas such as tank farms or pipes passing through fire walls. They are ordered to customer supplied specifications so they may be used for any size casing/carrier differential. These seals are excellent for eliminating the possibility of foreign material entering the opening between carrier and casing pipes.



**Casing Spacers (Non-Metallic)**

**Model PE Casing Spacers**

High density (linear), injection molded virgin polyethylene casing isolators/spacers provide positive insulation, high abrasion resistance and low coefficient of friction for a wide variety of double containment carrier/casing pipe applications. They are extremely light in weight and easy to handle during installation.



**Model HT Casing Spacers/Isolators**

A unique formulation of polymers is used in the manufacture of the Hi-Temp isolators/spacers giving them the ability to be used for applications that may reach 266-degrees F. (130°). In addition to heat resistance, they also offer excellent insulation, high abrasion resistance and low coefficient of friction for a wide variety of double containment carrier/casing pipe applications.

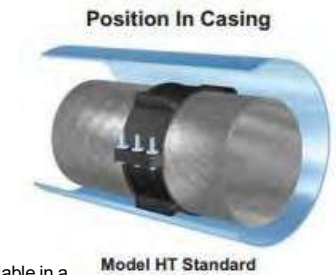

**Ranger II® Casing Spacers**

The Ranger II® is an all non-metallic casing isolator/spacer system that uses molded segments to encircle the carrier pipe. Each segment includes at least one molded-in runner and one slide lock. Customers may choose from any one of five different size bands to allow correct sizing for carrier pipe O.D. ranges from 0.83" up to 98.43" in diameter.

Runners are available in a variety of heights to allow for desired carrier pipe placement in casing.

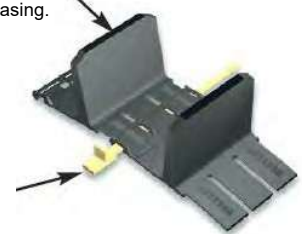

Slide-Lock is inserted into channel to close and lock the segments together. Slide-Lock removal and re-insertion will cinch the segments together for final tightening against carrier pipe.

**Casing Spacers (Metallic)**

**Coated Casing Spacers (Model C)**

cross-linked polymer coated casing spacers/isolators are often selected due to their strength and excellent corrosion resistance.



**Multiple Casing Spacers-Custom**

PSI Models C (coated) and S (stainless steel) may be designed and fabricated to meet the needs of your custom project. All custom multiple carrier spacers share the same features as our single carrier spacers. However, the multiple carrier spacers are considerably more complex and therefore require more detailed design considerations.



**Century Sleeves**

**Model CS Sleeves**

Century-Line® Pipe Penetration Sleeves are used to create circular sleeved holes in concrete poured barriers including; walls, floors, ceilings, structural supports and tank footings. Molded from non-conductive, high impact resistant HDPE, Century-Line® sleeves are lightweight and easily installed by one construction worker. They are available in 16 diameters ranging from 2" to 25" and shipped, from stock, in any desired length. Century-Line® sleeves are engineered to mate with Link-Seal® modular mechanical seals for a lifetime of leak-proof performance. PSI-Thunderline/Link-Seal® is your one-stop source for everything you need to effectively seal the annular space between pipes and concrete barriers through which they pass.



**Model WS Sleeves (Steel)**

Model WS Steel Wall Sleeves are an excellent choice for installations where the Link-Seal® Modular Seal and WS sleeve assembly would be subject to extremely high temperatures or where fire seals are specified.

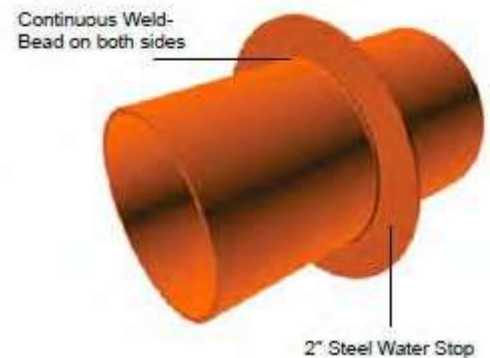

## Titan® Flange Spreader

Titan Flange Spreaders are designed for the most safety in separating pipe and ring-type-joint flanges used in refineries, petrochemical, agrichemical and chemical plants, electrical and gas utility stations, pipe lines, oil fields and various industrial facilities.

- Handles ASA raised face, ring-type-joint and cast iron flanges
- Only require few sizes to handle all flanges
- Compact, light and easy to carry
- Prevents safety incidents
- Comes in 7 lb. to 20 lb. weights



TITAN Flange Spreader			
CATALOG	INSIDE FRAME	PIN	WEIGHT
N14	2-3/4"	5/8"	8 lbs.
N48	3-3/4"	3/4"	9 lbs.
N812	4-7/8"	7/8"	10 lbs.
N1216	6-1/8"	1"	15 lbs.
N1620	7-1/2"	1-1/8"	18 lbs.
N2024	9-1/8"	1-1/4"	20 lbs.

## Pop-It® Tool Flange Spreader



- Used for flange spreading, blinding flanges, valve service, levelling, lifting, alignment, prying, moving, wedging, etc.
- Lightweight, compact, fits in .070" of space (fits in toolbox)
- Hand operated, unique for tight spots ratchet
- Weight: 10.5 lbs.; Height: 11.75"; Toe width: 3.5"
- Rated capacity: 100 ft lbs Input and 10,000 lbs of Lift



## Heavy Duty Pop-It® Flange Spreader



- Input 300 ft lbs torque on second & third step
- Output 30,000 ft lbs on second & third step
- First toe to start work
- Total height 15-1/2"
- Total weight 32 lbs
- Travel height 5-1/2"
- Travel height with legs extended is 8"
- Penetration 1/2" first step, 1" 2nd step, 1-1/2" 3rd step
- Ratchet handle mechanically attached to tool

## Flange Alignment Tool

Titan flange alignment tools are a simple and, effective way to align any flange for any alignment job. All the operator has to do is to slide the thin end of the pin through the holes in the two flanges that most closely line up and turn the pin with a wrench. As the pin spins the holes will begin to line up. The tool's tapered shaft has a patented end. This detail eliminates the need for hammering, prying and pushing when attempting to line up flange bolt holes. If necessary you can use a second pin on the opposite side of the flange to get the flange to completely line up. At this point all the operator has to do is slide the bolts through the aligned bolt holes and tighten them up to the correct torque rating.



Flange Aligning Tool Sets are available In pairs of three, four, five and 6 sizes. All sets come in a custom foam fitted tool box. The tool box is a handy way to keep all the pins together and to keep them from being lost or missed placed, and from being damaged sitting in the bottom of an old tool box.



Available Alignment Pin Sizes			
Catalog #	Bolt Hole Size	Length	Weight
FT00	3/8"	2 1/8"	1 1/4 ozs.
FT0	1/2"	2 3/8"	2 1/4 ozs.
FT01	5/8"	2 3/4"	4 ozs.
FT02	3/4"	3 1/4"	7 ozs.
FT03	7/8"	3 1/2"	11 ozs.
FT04	1"	4"	1 lb.
FT06	1 1/8"	5"	1 1/2 lbs.
FT08	1 1/4"	5 1/2"	2 lbs.
FT1012	1 3/8"	6 1/4"	2 7/8 lbs.
FT14	1 1/2"	6 1/2"	3 1/4 lbs.
FT16	1 5/8"	7 1/4"	4 1/8 lbs.
FT1820	1 3/4"	7 7/8"	4 3/4 lbs.
FT2426	2"	9"	6 5/8 lbs.
FT30	2 1/8"	12"	10 3/8 lbs.
FT34	2 3/8"	13 1/4"	13 1/8 lbs.
FT3642	2 5/8"	14"	16 7/8 lbs.

Extral Long Sizes			
Catalog #	Bolt Hole Size	Length	Weight
FT0L	1/2"	5 3/8"	10 ozs.
FT01L	5/8"	5 3/4"	12 ozs.
FT02L	3/4"	6 1/4"	14 ozs.
FT03L	7/8"	6 1/2"	1 1/8 lbs.
FT04L	1"	7"	1 1/2 lbs.
FT06L	1 1/8"	8"	2 1/4 lbs.
FT08L	1 1/4"	8 1/2"	3 lbs.
FT1012L	1 3/8"	9 1/4"	4 lbs.
FT14L	1 1/2"	9 1/2"	4 1/2 lbs.
FT16L	1 5/8"	10 1/4"	5 3/4 lbs.
FT1820L	1 3/4"	10 7/8"	6 1/4 lbs.
FT2426L	2"	12"	7 1/2 lbs.
FT30L	2 1/8"	15"	13 lbs.
FT34L	2 3/8"	16 1/4"	15 lbs.
FT3642L	2 5/8"	17"	18 lbs.

FTS24 Includes 3 pairs of pins: FT02,FT03,FT04  
 FTS26 Includes 4 pairs of pins: FT02,FT03,FT04,FT06  
 FTS28 Includes 5 pairs of pins: FT02,FT03,FT04,FT06,FT08  
 FTS212 Includes 6 pairs of pins: FT02,FT03,FT04,FT06,FT08,  
 FT1012

There are also "Extra Long" Flange Aligning Pin sets available

FTS24L Includes 3 pairs of pins: FT02L,FT03L, FT04L  
 FTS26L Includes 4 pairs of pins: FT02L,FT03L,FT04L,FT06L  
 FTS28L Includes 5 pairs of pins: FT02L,FT03L,FT04L,FT06L,FT08L  
 FTS212L Includes 6 pairs of pins: FT02L,FT03L,FT04L,FT06L,  
 FT08L,FT1012L

## Flange Line Up Pins

### H&M Quick-Acting Flange Pins

With H&M's Quick-Acting Flange Pins welding occurs in minutes with very little fit-up time. What's the secret? The secret is in the knob. Just tilt the knob to bypass the flange pin threads, then straighten the knob to grip the threads for tight, positive clamping. Removal is just as quick and easy. Loosen the knob, tilt it and remove. Endless threading and unthreading of the flange pins have been eliminated.



### Mathey Flange Line Up Pins

Flange Line Up Pins aid the welder in checking or obtaining critical alignment of flange to the pipe. The Mathey Dearman Stainless Steel Aligning Pins are multi-purpose to rapidly align carbon steel and stainless steel. Additionally, the spring and end cap allow for expansion during welding.

A simple push of the "Thumb-Lock" allows the flange pin to quickly release itself from the flange.

In the Wobble Nut FLUP variation, the FLUP is unscrewed 3/4 turn, tilted and released from the flange in seconds.

Quick precise flange to pipe alignment can be obtained with the stainless steel Flange Line Up Pins, which save valuable fit-up time, eliminating costly rework due to improper alignment.



### Sumner Flange Leveler

- Two hole & level in one time-saving operation
- Uses push button Quik Pin nuts for fast action
- Features stub Acme threads for maximum clamping & hardened steel for lasting use
- Automatically centers in flange holes 5/8" to 1-5/8" (16 to 42 mm)
- Easily replaceable vials in the event of breakage



### Sumner Quik Pins

Simple Operation

1. Push the spring-loaded button
2. Separate pin from nut
3. Insert into top two flange holes
4. Push spring button and reinsert onto pin
5. Quarter turn to tighten



## Broadhead Bull Pins

- Forged, heat-treated bull pin increases efficiency by providing a larger striking surface.
- Head design also reduces chance of pin slipping from the hand when aligning holes.
- Angled head and smooth blending of radii increase strength and reduce the danger of chipping.
- Below the head, squared-off shoulders have been forged to provide a surface for applying wrench to loosen wedged bull pins.
- Long, even taper reduces binding and hang-up.
- Added resistance to "mushrooming" permitting much longer use than is possible with conventional designs.
- Heat-treated for strength.



## Standard Bull Pins

- Machined from quality alloy steel.
- Standard design offers greater initial economy, but no added protection against mushrooming.
- Heat-treated for strength.



## Drift Pins

- Machined from 4140 steel.
- Tapers are uniform and blend into body diameter.
- Tough, forged steel will properly end-pein in use.
- Heat-treated for strength.



## Flange and Pipe Rotator

Flange and pipe rotators have brass bushings and grease fittings on both ends - always keep well greased.

The base channel frame can be bolted to a welding table or other surface with 3-1/2" bolts. Keep the overhang from edge of table or other bolting surface as short as possible. Channel frame can also be secured in a vice for light duty work - never overload when in vice.



## Flange Lifting Tool

The Flange lifter provides a safe and easy method of installing and removing blind and weld neck flanges. By eliminating the need to attach a lifting eye to the flange, the tool is both time and cost effective. Each flange lifter is load tested and magnetic particle inspected to ensure safety and quality.

- No lifting eye required
- Easy installation and removal of blind and weld neck flanges
- Safe
- Saves time and money
- Designed to comply with ASME specifications B30.20 and BTH-1,
- Design Category B, Service Class 4
- Serialized and stamped with Load Rating
- Supplied with Data Book that contains operating instructions, warnings, load test certificates and MPI certificates.



Catalog No.	For Use On	Fits Bolt Size	Fits Flange Thickness	Weight	Rated Load
FLA112	Blind Flanges Only	3/4" - 1-1/2"	1/2" - 3-3/4"	21 lbs	1000 lbs
FLA212	Blind Flanges Only	1-1/2" - 2-1/2"	1/2" - 7"	37-1/4 lbs	2000 lbs
FLA1000	Blind & Weld Neck Flanges	3/4" - 2-1/4"	1" - 6-3/16"	19-5/8 lbs	1000 lbs
FLA5000	Blind & Weld Neck Flanges	3/4" - 4"	1" - 11-1/16"	45-7/8 lbs	5000 lbs

## FL1020 & FL2448 Horizontal Flange Lifters



The Flange Lifter is a lightweight, high-capacity lifting solution designed specifically for the safe and efficient handling of large pipe flanges in the axial direction.

- **Easy Sliding Telescopic Arms:** Quickly adjust to accommodate various flange sizes without tools.
- **Quick Release Pins:** Streamline setup and teardown, saving time on the job site.
- **Removable Nylon Wear Pads:** Provide a secure grip while protecting flange surfaces from damage.
- **Compliance:** Meets ASME B30.20 and BTH-1 standards for below-the-hook lifting devices.
- **Two available sizes:** FL1020 for 10" to 20" flanges, FL2448 for 24" to 48" flanges.



## Disc Style Flange Protection

(Available in all sizes and classes with or without holes)

Available in the following materials:

- Corrugated Plastic
- Medium Density Fiber Board (MDF)
- PVC Plastic HDPE
- Plywood



## LDPE Stud Hole Flange Protection

ANSI#

- 1/2 - 12" 150# - 600
- 1/2 - 6" 900 - 1500#



## Flange Armour - Flange Protection

Flange Armour improves time and cost savings for any business involved with the production of flanges of any type and size. Our research and development of the first generation of Flange Armour is already changing the way flange protection is managed by Companies.

Industries have recognized that using Flange Armour helps improve the quality of their flanged assets and reduces costly rework caused during production and delivery stages. Our clients are excited about improved delivery time, workmanship and ease of use.

### Benefits:

- Improved flange raised face protection
- Reduces defects and damage
- Reduces capital costs
- Reduces inspection time
- Improved Predictability / reliability
- Quick and easy use
- High visibility
- Improves fabrication yield and throughput
- Reduces fabrication costs
- Reduces shipping preparation time
- Reduces assembly time / costs
- Light weight
- Recyclable / Reusable
- Improves product delivery time



### Uses:

- Pipe spools / equipment flanges
- Construction projects
- Warehouse / yard preservation
- Asset lifecycle
- Valve flange face protection
- Commissioning / Immobilization
- Turn-arounds / shutdowns
- High visibility for safe transportation



### No tools Required:

- Reduced defects and damage
- Reduces refacing costs
- Improved assembly time / cost
- Improved shipping preparation time

## Pipe Armour

Pipe Armour is the new technology in Pipe End Protection that improves current processes and eliminates current application frustrations experienced by facility personnel. Pipe Armour pipe end protection advancements makes it the logical choice by companies. Pipe Armour is improving application processes, preparation and delivery times and will be the future in Pipe End Protection.

**Benefits:**

- Advanced Design
- Improved Industry Practice
- Quick / Easy application
- Recyclable / Reusable
- Improved Predictability and reliability
- Reduced shipping preparation time
- Improves warehouse / yard preservation

**Uses:**

- Pipe transportation
- Facility / Construction projects
- Pipeline projects
- Sandblasting
- Valve pup piece protection
- Commissioning projects
- Warehouse / yard preservation
- Coating
- Material: Polypropylene (Black)

*Partial box quantities are available for orders within CANADA only. Orders outside of Canada will need to meet the following box qty's...*

Name	Product No.	Description	Pkg. Qty.
2" Pipe Armour	2"-PA	Pipe Armour Cap	1200
3" Pipe Armour	3"-PA	Pipe Armour Cap	400
4" Pipe Armour	4"-PA	Pipe Armour Cap	225
6" Pipe Armour	6"-PA	Pipe Armour Cap	80
8" Pipe Armour	8"-PA	Pipe Armour Cap	80
10" Pipe Armour	10"-PA	Pipe Armour Cap	40
12" Pipe Armour	12"-PA	Pipe Armour Cap	25
14" Pipe Armour	14"-PA	Pipe Armour Cap	16
16" Pipe Armour	16"-PA	Pipe Armour Cap	16
18" Pipe Armour	18"-PA	Pipe Armour Cap	16
20" Pipe Armour	20"-PA	Pipe Armour Cap	14
24" Pipe Armour	24"-PA	Pipe Armour Cap	12
30" Pipe Armour	30"-PA	Pipe Armour Cap	10
36" Pipe Armour	36"-PA	Pipe Armour Cap	10
42" Pipe Armour	42"-PA	Pipe Armour Cap	10



## Plastic End Caps

Available in 1/4" - 60" diameter  
Provides cost effective bevel protection and seals out contaminants for shipping and storage



## Cathodic Test Post Station

The Cathodic Test Post Station monitors electrical currents and potentials associated with all types of underground piping, cables and other metallic structures



## Cadweld Connection Kit

Cadweld Connection Kit helps attach cathodic protection leads to pipes, tanks and structures and comes with a variety of cathodic protection connections and accessories



## Royston Handy Caps

The Royston Handy Cap is a prefabricated assembly specifically designed for Cathodic Protection leads to pipes and tanks. When pressed by hand into position over the anode lead wire weld, it forms a thick, highly resistant electrical insulation seal over the weld, the end of the lead wire and the surrounding area of the pipe or tank.



## Trencher Parts, Teeth and Pockets

Proline sells trencher teeth, belts and parts for the leading brands of trenchers such as Buckeye®, Barber Greene® and Cleveland®.

- Proline #909 trencher teeth and #9 pockets
- #1 drive sprockets
- Upper and lower truck rollers
- Various wheel segments available
- Large inventory of replacement parts



## Auger Teeth and Bits

Proline supplies a variety of tooling for the auger, caisson and drilling industries. We also offer a range of auger flighting from leading manufacturers.



Metrotech®, one of the original names in Pipe & Cable locating, has been producing well tried and tested locators for over forty years. Metrotech® locators include a distance sensitive left/right guidance system (pioneered by Metrotech®) to provide accurate easy locating. The VM-810/VM-850 and vLoc-9800 are the locators of choice for many Customers around the world.

## VM-810 / VM-850



The VM-810/VM-850 is designed specifically as a single frequency true left/right locator with separated twin response left/right antennas.

- One Button Operation
- Distance Sensitive Left/Right Guidance™
- Fast Response
- Improved Clear & Backlit Display
- Full Crisp Digital Sound
- Precise Single Frequency
- Lightweight Rugged Construction
- Water Resistant (IP54)
- Retractable Antenna
- Excellent Battery Life



## vLoc3-9800

The vLoc3-9800 utility locator introduces new innovative tools for locating buried utilities assuring damage prevention while gathering information for analysis.

- Fully-automatic gain control
- Optional receiver-to-transmitter link
- Compass indicator
- Distance Sensitive Left / Right Guidance
- Internal data logging
- Optional Bluetooth connectivity
- Optional plug-in EMS locator



## vLoc3-5000



The vLoc3-5000 utility locator brings an innovative element of digital signal processing, position capturing and broadband frequency selection to buried utility locating.

- Internal GPS, plus external GPS via optional Bluetooth module
- VM-MAP smartphone app for real-time mapping (time/date, depth, current, comments)
- Dual screened 3D antennas with on-screen signal distortion indication
- Vector Locate for fully automatic non-walkover locating
- Transverse Graph showing peak and null simultaneously (instant distortion measurement)
- Plan View showing relative cable orientation at any angle
- Graphical Sonde screen with guidance arrows (including vertical sonde location)
- Eight passive locate modes plus fault-find mode
- SD mode (direction of outgoing current)
- Signal Select™ to measure signal bleed-over/coupling to other utilities
- Configurable frequencies from 98 Hz to 200 kHz
- User-configurable audio and vibration alerts (shallow depth, overload, overhead cables, excessive swing)
- Optional plug-in EMS “foot” for locating buried markers



## vLoc3 RTK-Pro

The vLoc3 RTK-Pro receiver is the first to add RTK GNSS accuracy to a utility locator, enabling collection of utility location data with survey-grade geographical accuracy.

- RTK GNSS accuracy with internal 4G LTE cellular module
- Connects to NTRIP RTK caster and receives RTCM 3 corrections
- Survey-grade capture of both utility locate data and geographic position
- Field data sent to the cloud and retained in onboard storage for review/export
- Eight passive locate modes
- Fault-find mode
- SD mode (direction of outgoing current)
- Configurable frequencies from 98 Hz to 200 kHz
- User-configurable visual and vibration alerts (shallow depth, overload, overhead cables, excessive swing)



*Vivax vLoc3 Pro*

**Key Features**

- Color-coded EM distortion warnings
- Offset vector locate mode
- Optional receiver/transmitter link
- Cloud-based data warehousing
- Internal data logging and optional Bluetooth connectivity

**In the transmitter...**

- Both receiver and transmitter allow use of any frequency between 98Hz and 200 kHz
- SD mode for positive location in congested areas
- Lightweight – Only 7.15 lbs. / 3.24 kg with Li-ion battery
- A wide range of transmitters are available for use with the vLocPro receiver.
- The Loc3Tx, Loc3 5WTx, Loc3 10WTx are available with or without internal lithium batteries.



**Loc-1Tx (1 watt) transmitter** is a three frequency transmitter for short range applications.



**Loc-5Tx (5 watt) transmitter** has multiple frequencies, signal direction and sheath fault locating modes.



**Loc-10Tx (10 watt) transmitter** has our maximum number of frequencies and a true 10W of output, together with signal direction and sheath fault locating modes.

## VM-880 Ferrous Metal Detector

The VM-880 is the latest generation of the ever popular 880 ferrous metal locator. Enhancing existing features and adding new, it incorporates the following to enable fast location of buried or hidden assets:

- Excellent sensitivity
- Lightweight, just 1.54lbs (0.7kg)
- Improved ergonomics for comfort during prolonged usage
- Up to 26 hrs battery life from just 2 x AA (LR6) cells
- Ultra strong, submersible carbon fiber antenna tube
- Dot matrix LCD with backlight
- Audio and visual signal strength indicators
- Field polarity indicator
- Continuous battery level indication
- One touch auto sensitivity control with manual incremental control
- 50/60Hz proximity warning
- Unique screen inversion feature to aid pinpointing
- Soft carry bag supplied as standard



## VM-560

The VM-550 pipe and cable locator is general purpose locators used to detect buried pipe and cable services in a variety of situations. The VM-550 has achieved a compact and lightweight design without compromising strength and performance.

With a choice of passive power locating and active 8kHz and 83kHz frequencies the **VM-550** is designed to meet the requirements of those wishing to detect the presence of active power cables and also wishing to trace short ranges. It is particularly useful in helping to detect and trace short distance drop wires.

The **VM-550** transmitter can supply a very useful 1 watt signal power. Signal application can be either direct connection or, if there is no access point, Induction. With the addition of the optional signal clamp the **VM-550** transmitter can be applied to the target line no matter what the situation.



## Vivax Metrotech Accessories

Contact Proline for Vivax Metrotech parts, accessories, repairs and calibration.



In addition to servicing our manufactured equipment, PROLINE is also an authorized Warranty and Service Depot for most of the pipe equipment and supplies we distribute, such as:



**SPV**®



**VIVAX**  
**METROTECH**



